

2024



# LEATHERCRAFT

by OHD





# LEATHERCRAFT

by OHD

FOR THE QUALITY OBSESSED

From the first moment you sink into our collection of sofas, chairs, sectionals, and ottomans, you know you've found the most comfortable seat in the house.





## CONTENTS

Accent Chairs	5
Occasional Chairs	19
Swivel Chairs	35
Recliners & Vari-Tilts	44
Sofas & Loveseats	57
Sectionals	75
Benches & Accent Ottomans	88
Dining Chairs & Bar Stools	104
Executive Chairs	113
Contract Furniture	119
Manhattan Series	126
Wood & Nail Finishes	133
Features & Benefits	137
Seat Cushions & Pillows	138
Leather Care	140
Warranty	142
Mechanism Information	143
Numerical Index	150
Alphabetical Index	152





ACCENT CHAIRS



## ACCENT CHAIRS



214-02

### **Bamba Chair**

Outside: H31.5 W29 D34

Inside: H15 W25 D23

Seat: H17 Arm: H22.5



214-02-27

### **Bamba Chair**

Outside: H31.5 W29 D34

Inside: H15 W25 D23

Seat: H17 Arm: H22.5



214-02-28

### **Bamba Chair**

Outside: H31.5 W29 D34

Inside: H15 W25 D23

Seat: H17 Arm: H22.5



914

### **Carmel Sling Chair**

Outside: H34.5 W27 D35.5

Inside: H21 W25 D18

Seat: H19.5 Arm: H22



\*Standard Finish: Brushed Brass

\*Custom powdercoat finish can be applied. Call office for details.

\*Complementary 914-O Ottoman



## ACCENT CHAIRS



730

### Waning Chair

Outside: H35.5 W26.5 D26.5

Inside: H14 W22 D19

Seat: H20

\*Complementary Executive Swivel **GT-730-S**



915-RK

### Wrenn Sling Rocking Chair

Outside: H34 W28 D39.5

Inside: H23.5 W25 D20.5

Seat: H19 Arm H24.5

\*Complementary Ottoman **915-O**



705

### Andover Chair

Outside: H34 W27.5 D35.5

Inside: H19.5 W25.5 D19.5

Seat H20.5 Arm: H24

\*Complementary Loveseat **705-52**



763

### Oslo Chair

Outside: H35 W29 D36

Inside: H18 W22.5 D20

Seat: H19.5 Arm: H24

\*Complementary Ottoman **763-O**



## ACCENT CHAIRS



710

### **Napa Valley Wing Chair**

Outside: H42 W28 D34.5

Inside: H26 W22 D21

Seat: H21 Arm: H25



1261-17

### **Kellan Wing Chair**

Outside: H44 W29 D31

Inside: H22 W21.5 D21

Seat: H22 Arm: H23.5



4302

### **Blair Chair**

Outside: H43 W30 D40

Inside: H24 W23 D24

Seat: H19.5 Arm: H17.5



860

### **Jacoby Wing Wood Carved Chair**

Outside: H43.5 W28.5 D38

Inside: H22.5 W22 D21.5

Seat: H21 Arm: H24.5

\*See Price Book for Standard Features



# ACCENT CHAIRS

BEST SELLER



882

## San Baranto Chair

Outside: H41.5 W27 D36.5

Inside: H22 W20 D18-22

Seat: H18.5 Arm: H23

\*Complementary Ottoman **882-O**



706

## Naples Cane Chair

Outside: H38 W27 D32

Inside: H18.5 W23.5 D20

Seat: H22 Arm: H25



725

## Monastery Chair

Outside: H38 W29 D33

Inside: H19 W25.5 D20

Seat: H20 Arm: H25





*Featured on Season 5 of Paramount's "Yellowstone"*



## ACCENT CHAIRS



721

### **Mission Viejo Chair**

Outside: H36 W31.5 D36

Inside: H16 W25-23 D19

Seat: H21 Arm: H24



714

### **Nouvel Chair**

Outside: H35.5 W33 D37

Inside: H19 W25 D19-27

Seat: H19.5 Arm: H21

\*Complementary Ottoman **714-O**



717

### **Porter's Evolution Wing Chair**

Outside: H44 W28 D32.5

Inside: H23.5 W22.5 D17-23

Seat: H18 Arm: H23-24.5



709

### **Celtic Gate Chair**

Outside: H39.5 W30 D36

Inside: H20 W25 D20.5

Seat: H18 Arm: H25

## ACCENT CHAIRS



847

### Nantucket Cottage Chair

Outside: H39 W28 D38

Inside: H20 W23 D20

Seat: H19 Arm: H24

\*Complementary Ottoman **847-O**



764

### Atwood Chair

Outside: H38.5 W27.5 D33.5

Inside: H23 W24.5-22.5 D22.5

Seat: H29.5 Arm: H23



735

### Adelaide Chair

Outside: H38.5 W27.5 D30.5

Inside: H24 W22-19 D20.5

Seat: H19 Arm: 24.5



863

### Bonaparte Chair

Outside: H41 W31 D32

Inside: H23 W25 D17

Seat: H18 Arm: H24



## ACCENT CHAIRS



2398

**Hunter Accent Chair**

Outside: H35 W25 D28

Inside: H17 W19 D19

Seat: H20 Arm: H27



164

**Barrister's Lobby Chair**

Outside: H34.5 W29 D30

Inside: H15 W17.5 D18.5

Seat: H19.5 Arm: H26



337

**Lombard St. Bankers Chair**

Outside: H29.5 W26.D24.5

Inside: H11 W20 D19

Seat: H19.5 Arm: H26



337-C

**Lombard St. Bankers Caster Chair**

Outside: H29.5 W26.D24.5

Inside: H11 W20 D19

Seat: H19.5 Arm: H26

## ACCENT CHAIRS



219C

### **Rainer Game Chair**

Outside: H36 W26 D27

Inside: H16 W18 D21

Seat: H20 Arm: H24



877

### **Antoinette Chair**

Outside: H37.5 W26.5 D30

Inside: H18 W20 D21

Seat: H19 Arm: H24.5



701

### **Delray Cove Chair**

Outside: H40 W29.5 D35

Inside: H20 W25 D18-23

Seat: H18 Arm: H24.5



841

### **All Hallows Chair**

Outside: H36 W28 D37

Inside: H21 W22 D18

Seat: H15 Arm: H24

\*Complementary Ottoman **841-O**



## ACCENT CHAIRS



731

### **Toulouse Chair**

Outside: H42.5 W26.5 D27

Inside: H22 W19-23 D20

Seat: H21 Arm: H27.5



7112

### **French Empire Chair**

Outside: H35 W24 D26

Inside: H15 W20 D19

Seat: H20 Arm: H26



747

### **Bellini Chair**

Outside: H37 W27 D28

Inside: H20 W20.5 D24

Seat: H20 Arm: H25



839

### **Bergamo Chair**

Outside: H36 W27 D29

Inside: H19 W21 D25.5

Seat: H17 Arm: H29

## ACCENT CHAIRS



708

### **Florence Chair**

Outside: H38 W28 D26

Inside: H20 W23 D21

Seat: H19 Arm: H26



774

### **Valois Chair**

Outside: H41 W28 D30

Inside: H23 W20 D22

Seat: H19 Arm: H25



718

### **Valois Button Chair**

Outside: H41 W28 D30

Inside: H23 W20 D22

Seat: H19 Arm: H25



1231-17

### **Kelly Wing Chair**

Outside: H42 W30 D30

Inside: H23 W20 D22

Seat: H21 Arm: H25

## ACCENT CHAIRS



713

### Victoria's Transition Wing Chair

Outside: H51 W23 D37  
Inside: H29 W26-23 D20-24  
Seat: H22 Arm: H25.5



859

### Grand Victorian Wing Chair

Outside: H51 W31.5 D37  
Inside: H29 W26-23 D20-24  
Seat: H22 Arm: H26



1231-18

### Kelly Wing Chair

Outside: H42 W30 D30  
Inside: H23 W20 D22  
Seat: H21 Arm: H25





## ACCENT CHAIRS



1241-17

### **Alistair Wing Chair**

Outside: H43 W33 D34

Inside: H25 W23 D22

Seat: H21 Arm: H25



1241-18

### **Alistair Wing Chair**

Outside: H43 W33 D34

Inside: H25 W23 D22

Seat: H21 Arm: H25



1241-38

### **Alistair Wing Chair**

Outside: H43 W33 D34

Inside: H25 W23 D22

Seat: H21 Arm: H25



141-38

### **Reynolds Wing Chair**

Outside: H41 W35 D35

Inside: H22 W19 D22

Seat: H20 Arm: H27

### **143-3 Reynolds Ottoman**

Outside: H16 W24 D19

\*See Price Book for Standard Features

## ACCENT CHAIRS



846

### **Bosworth Chair**

Outside: H53 W32 D32

Inside: H32 W21 D21

Seat: H21 Arm: H29



813

### **Haute Garrone Wood Carved Wing Chair**

Outside: H49 W34 D40

Inside: H27 W25 D24

Seat: H22 Arm: H27

### **813-O Haute Garrone Ottoman**

Outside: H20 W30 D22

## TRIM

Why do we use solid brass nail trim? Because we'd know if we use lesser quality, less expensive steel nails with a brass finish. Besides, in time you'd know, when they begin to rust.. Each individual nail is set by hand, not machine. It takes human hands to precisely place each nail, sensing the ever changing thickness and textures of the top grain leather. A mechanized pneumatic nail machine does not have the tactical senses to produce the refined end product, and quite frankly, we hope they are never developed. Old world craftsmanship is still alive in our trim department.



OCCASIONAL CHAIRS



## OCCASIONAL CHAIRS



926-02

### Cloud Nine Chair

Outside: H35 W35 D38  
Inside: H14.5 W23 D22  
Seat: H20.5 Arm: H27.5

### 926-03 Cloud Nine Ottoman

Outside: H18.5 W26.5 D20.5



933-02

### Shelly Chair

Outside: H38.5 W36.5 D40  
Inside: H16 W26.5 D23  
Seat: H20.5 Arm: H23.5

### 933-03 Shelly Ottoman

Outside: H17.5 W32 D26.5



558

### Findlay Chair

Outside: H37 W31.5 D38.5  
Inside: H19 W25 D22  
Seat: H19 Arm: H23.5

### 558-O Findlay Ottoman

Outside: H15 W26 D21



599

### Pascal Chair

Outside: H37 W31.5 D38.5  
Inside: H19 W25 D22  
Seat: H19 Arm: H24.5

### 599-O Pascal Ottoman

Outside: H15 W26 D21

## OCCASIONAL CHAIRS



695

### **Kenton Chair**

Outside: H35 W30 D31  
Inside: H21 W24 D21  
Seat: H19.5 Arm: H25



317

### **Austin Chair**

Outside: H34 W35 D37  
Inside: H16 W23 D22  
Seat: H20 Arm: H25.5



277-CH

### **Peyton Chair**

Outside: H36 W36.5 D40.5  
Inside: H21 W26.5 D22.5  
Seat: H18 Arm: H22.5

\*Complementary Ottoman **277-O**



407

### **Palmyra Chair**

Outside: H32 W47 D29  
Inside: H15 W27 D22  
Seat: H19 Arm: H22.75

## OCCASIONAL CHAIRS



282-CH

**Sadler Chair**

Outside: H35 W27.5 D38

Inside: H19 W20 D22

Seat: H19.5 Arm: H21.5



283-CH

**Dorset Chair**

Outside: H28.5 W30 D36

Inside: H15 W22 D24

Seat: H21.5 Arm: H21.5-25



416

**Punch Tavern Chair**

Outside: H34 W31 D35

Inside: H15 W22 D22

Seat: H19 Arm: H25

\*Complementary Ottoman **416-O**



305

**Leeds Chair**

Outside: H37 W34.5 D37

Inside: H17 W23 D20

Seat: H19.5 Arm: H25

\*Complementary Ottoman **305-O**



## OCCASIONAL CHAIRS



561-CH

### **Padliegh Chair**

Outside: H32.5-34.5 W31.5 D36

Inside: H14.5 W22 D20-26

Seat: H19.5 Arm: H23.5



2898

### **Lodge Chair**

Outside: H35 W30 D33

Inside: H16 W21 D22

Seat: H20 Arm: H28

Also Available:

2898SW Swivel Chair



2852

### **Tate Chair**

Outside: H34 W29 D33

Inside: H13.5 W20 D21

Seat: H20 Arm: H26.5



278-CH

### **Reilly Chair**

Outside: H36 W36.5 D40.5

Inside: H21 W26.5 D22.5

Seat: H18 Arm: H22.5

### **278-O Reilly Ottoman**

Outside: H17 W26 D20.5

## OCCASIONAL CHAIRS



303

### **Garrison Chair**

Outside: H36 W35 D36

Inside: H18 W23 D20

Seat: H19.5 Arm:H25

### **303-O Garrison Ottoman**

Outside: H18 W25 D20



304

### **Keighley Chair**

Outside: H37 W32.5 D37

Inside: H18 W23 D20

Seat: H19.5 Arm: H26

### **304-O Keighley Ottoman**

Outside: H18 W25 D20



306

### **Shelby Chair**

Outside: H36 W35 D36

Inside: H18 W23 D20

Seat: H19.5 Arm: H25

### **306-O Shelby Ottoman**

Outside: H18 W25 D20



579

### **Carmichael Chair**

Outside: H37 W39 D40

Inside: H18 W24 D19

Seat: H19 Arm: H26

### **579-O Carmichael Ottoman**

Outside: H19 W29 D20.5

## OCCASIONAL CHAIRS



568

### French Salon Chair

Outside: H36 W35 D38.5

Inside: H18 W24-21 D21

Seat: H19 Arm: H25



556

### Kensington Wing Chair

Outside: H38 W30 D36

Inside: H22 W22 D21.5

Seat: H19.5 Arm: H24



415

### Duncan Chair

Outside: H39 W29 D37

Inside: H19 W22 D21

Seat: H20 Arm: H25

\*Complementary Ottoman **415-O**



538

### Loxley Chair

Outside: H37.5 W31.5 D39

Inside: H19.5 W22.5 D19

Seat: H19.5 Arm: H23.5

### 538-O Loxley Ottoman

Outside: H16 W27 D22.5



## OCCASIONAL CHAIRS



404-32

### **Halifax Armless Chair**

Outside: H38 W32.75 D33

Inside: H19 W32.75 D20

Seat: H22.5

\*Complementary Settee **404-64**



404

### **Halifax Corner Chair**

Outside: H37.5 W33 D33

Inside: H16.5 W20 D20

Seat: H22 Arm: H31

\*Complementary Settee **404-64**



## OCCASIONAL CHAIRS



2632

**Breckenridge Chair**

Outside: H37 W34 D37

Inside: H16 W24 D22

Seat: H21 Arm: H24

Also Available:

2633 Ottoman

2630 Sofa

2635 Loveseat



548

**Devonshire Chair**

Outside: H37 W34.5 D42.5

Inside: H19 W22.5 D23

Seat: H18.5 Arm: H23.5

\*Complementary Ottoman **548-O**



547

**Bingeborough Chair**

Outside: H40 W34.5 D41

Inside: H21 W22.5 D23

Seat: H22 Arm: H23

**547-O Bingeborough Ottoman**

Outside: H16 W27.5 D22.5



525

**Dowgate Hill Chair**

Outside: H37 W31.5 D41

Inside: H19 W22 D21

Seat: H20 Arm: H25

**525-O Dowgate Hill Ottoman**

Outside: H16 W28 D20

## OCCASIONAL CHAIRS



432

### **Richardson Ave Chair**

Outside: H35 W31 D41

Inside: H16 W23 D21

Seat: H19 Arm: H25

### **432-O Richardson Ave Ottoman**

Outside: H17 W26 D22



437

### **Carlisle Chair**

Outside: H34 W34 D40

Inside: H16 W20 D23

Seat: H18 Arm: H24

\*Complementary Ottoman **437-O**



409

### **Holborn Chair**

Outside: H34 W34 D41

Inside: H16 W20 D22

Seat: H18 Arm: H23

\*Complementary Ottoman **409-O**



477

### **Isabella Chair**

Outside: H39 W28.5 D39.5

Inside: H19 W21 D21

Seat: H20 Arm: H25.5

### **477-O Isabella Ottoman**

Outside: H17 W24.5 D20.5

BEST SELLER



## OCCASIONAL CHAIRS



524

### Lindsay Chair

Outside: H37 W31.5 D40.5

Inside: H19 W22 D21

Seat: H21 Arm: H25

### 524-O Lindsay Ottoman

Outside: H16 W28 D20



526

### Braidwood Chair

Outside: H36 W32.5 D43

Inside: H18 W21.5 D21

Seat: H18 Arm: H25

### 526-O Braidwood Ottoman

Outside: H16 W28 D20



466

### Keats Chair

Outside: H39 W28 D35

Inside: H18.5 W21 D21

Seat: H20 Arm: H23



597

### Whitby Fireside Wing Chair

Outside: H41.5 W30 D35.5

Inside: H24 W19 D18-23

Seat: H18.5 Arm: H23

## OCCASIONAL CHAIRS



1152

### **Wrenn Chair**

Outside: H40 W35 D40

Inside: H19 W24 D22

Seat: H21 Arm: H24.5

Also Available:

1153-4 Ottoman



410

### **Farringdon Chair**

Outside: H37 W32 D39

Inside: H18 W20 D20

Seat: H19 Arm: H25

### **410-O Farringdon Ottoman**

Outside: H16 W28 D21



510

### **Finsbury Chair**

Outside: H38.5 W35 D41

Inside: H20 W21 D20.5

Seat: H19 Arm: H26.5

### **510-O Finsbury Ottoman**

Outside: H16 W28 D20



441-CH

### **Cavendish Chair**

Outside: H38 W33.5 D40.5

Inside: H18.5 W21 D20.5

Seat: H20 Arm: H24

### **441-O Cavendish Ottoman**

Outside: H16 W28 D20

## OCCASIONAL CHAIRS



2672

### **Robinson Chair**

Outside: H35 W38 D39

Inside: H16 W21 D21

Seat: H19 Arm: H24

### **Robinson Ottoman**

Outside: H15 W28 D22



390

### **Bishopgate Chair**

Outside: H38 W36 D42

Inside: H20 W21 D22

Seat: H18 Arm: H25

### **390-O Bishopgate Ottoman**

Outside: H17 W28 D21



1052

### **Bradley Chair**

Outside: H36 W35 D40

Inside: H18 W21 D21

Seat: H19 Arm: H23

Also Available:

1133 Bradley Ottoman

1057 Recliner



1042

### **Blayne Chair**

Outside: H36 W35 D40

Inside: H18 W21 D21

Seat: H20 Arm: H23

### **1043 Blayne Ottoman**

Outside: H16 W29 D22



## OCCASIONAL CHAIRS



593-45

### **Orleans Chair & A Half**

Outside: H34 W38 D38  
Inside: H17 W27 D21.5  
Seat: H19.5 Arm: H26



3332

### **Logan Chair**

Outside: H35 W45 D40  
Inside: H17 W20 D25  
Seat: H20 Arm: H28

### **3333 Logan Ottoman**

Outside: H17 W27 D24

Also Available:  
3330 Sofa  
3335 Loveseat  
3330 Sectional



435

### **Aldersgate Chair**

Outside: H38 W39 D45  
Inside: H20 W23 D24  
Seat: H18 Arm: H26

### **435-O Aldersgate Ottoman**

Outside: H17 W25 D21



435-47

### **Aldersgate Chair and Half**

Outside: H38 W47 D45  
Inside: H20 W29 DF24  
Seat: H18 Arm: H26

### **435-30 Aldersgate Ottoman & A Half**

Outside: H17 W30 D30

BEST SELLER

## OCCASIONAL CHAIRS



454

### **MiddlePark Chair**

Outside: H38 W33 D41

Inside: H19 W20 D21

Seat: H20 Arm: H26

\*Complementary Ottoman **454-O**



506

### **Marlborough Lounge Chair**

Outside: H42 W35.5 D38

Inside: H20 W20.5 D25

Seat: H20 Arm: H25

\*Complementary Ottoman **506-O**



1652

### **Soho Chair**

Outside: H35 W31 D34.5

Inside: H17 W21 D22

Seat: H18 Arm: H23

Also Available:

1652-SW Swivel Chair



536

### **Wolfcreek Pass Chair**

Outside: H37.5 W30 D40

Inside: H22 SW21 D21

Seat: H18.5 Arm: H25.5

\*Complementary Ottoman **536-O**

## OCCASIONAL CHAIRS



527

### **Stanhope Chesterfield Chair**

Outside: H32 W45 D38

Inside: H16 W23 D24

Seat: H20 Arm: H32



1012

### **St. Lucia Chair**

Outside: H37 W38 D42

Inside: H16 W21 D23

Seat: H21 Arm: H26

### **1013 St. Lucia Ottoman**

Outside: H18 W28 D22

Also Available:

1010 Sofa

1015 Loveseat



292-19

### **Kirkland Lounge Chair**

Outside: H33 W32 D32

Inside: H19 W22 D21

Seat: H20 Arm: H23

### **293 Kirkland Ottoman**

Outside: H18 W27 D20

Also Available:

297-07 Recliner







SWIVEL CHAIRS

## SWIVEL CHAIRS



4612-SW

### **Roush Swivel Chair**

Outside: H32 W34.5 D34.5

Inside: H12.5 W24 D25.5

Seat: H18 Arm: H27



4342-SW

### **Susie Q Swivel Chair**

Outside: H30.5 W31.5 D31

Inside: H11 W20.5 D21.5

Seat: H19.5 Arm: H25



4212

### **Romneus Swivel Chair**

Outside: H31 W32 D31

Inside: H13 W20 D22

Seat: H20 Arm: H25



920-02SW

### **Manhattan Swivel Chair**

Outside: H36 W37 D37

Inside: H16 W24 D22

Seat: H20 Arm: H24

BEST SELLER

## SWIVEL CHAIRS



272-S

### Sadler II Swivel Chair

Outside: H35 W27.5 D38

Inside: H19 W20 D22

Seat: H19.5 Arm: H21.5

\*Top-Stitching Detail - No Welt

SMALL SPACE'S  
BEST FRIEND



282-S

### Sadler Swivel Chair

Outside: H35 W27.5 D38

Inside: H19 W20 D22

Seat: H19.5 Arm: H21.5

SMALL SPACE'S  
BEST FRIEND



273-S

### Dorset II Swivel Chair

Outside: H28.5 W30 D36

Inside: H15 W22 D24

Seat: H21.5 Arm: H21.5-25

\*Top-Stitching Detail - No Welt



283-S

### Dorset Swivel Chair

Outside: H28.5 W30 D36

Inside: H15 W22 D24

Seat: H21.5 Arm: H21.5-25



## SWIVEL CHAIRS

BEST SELLER



416-S

### **Punch Tavern Swivel Chair**

Outside: H33 W31 D36  
Inside: H14.5 W21.5 D23.5  
Seat: H19 Arm: H24.5

\*Complementary Caster Ottoman **416C-O**



2842

### **Zander Swivel Chair**

Outside: H30 W28 D32  
Inside: H11 W20 D20  
Seat: H21 Arm: H23



302-S

### **Bayswater Swivel Chair**

Outside: H35 W33 D38  
Inside: H17 W23 D19-21  
Seat: H19 Arm: H23-25

\*Complementary Caster Ottoman **302C-O**



561-S

### **Padliegh Swivel Chair**

Outside: H32-34 W31.5 D36  
Inside: H14 W22 D20-26  
Seat: H19 Arm: H23

## SWIVEL CHAIRS



598-S

### **Hampstead Swivel Chair**

Outside: H33 W30.5 D35

Inside: H18 W20 D23

Seat: H20 Arm: H25

\*Complementary Caster Ottoman **598C-O**



2898-SW

### **Lodge Swivel Chair**

Outside: H35 W30 D33

Inside: H16 W21 D22

Seat: H20 Arm: H28

Also Available:  
2898 Chair



2852-SW

### **Tate Swivel Chair**

Outside: H34 W29 D33

Inside: H13.5 W20 D21

Seat: H20 Arm: H26.5



525-S

### **Dowgate Hill Swivel**

Outside: H36.5 W31.5 D41

Inside: H19 W22 D21

Seat: H20 Arm: H26.5

\*Complementary Caster Ottoman **525C-O**

## SWIVEL CHAIRS



802-S

### **Knoll Swivel Chair**

Outside: H36 W33 D35

Inside: H21 W24 D20

Seat: H22 Arm: H26.5



592-S

### **Piccadilly Swivel Chair**

Outside: H35 W35 D38

Inside: H19 W23.5 D22.5

Seat: H21 Arm H27



277-S

### **Peyton Swivel Chair**

Outside: H36 W32.5 D38.5

Inside: H21 W24 D20.5

Seat: H18.5 Arm: H22

### **277C-O Peyton Caster Ottoman**

Outside: H17 W29 D20



278-S

### **Reilly Swivel Chair**

Outside: H36 W32.5 D38.5

Inside: H21 W24 D20.5

Seat: H18.5 Arm: H22

### **277C-O Reilly Caster Ottoman**

Outside: H17 W29 D20.5

## SWIVEL CHAIRS



541-S

### **Atticus Swivel Chair**

Outside: H34 W28.5 D34

Inside: H16.5 W21 D19

Seat: H20 Arm: H24



545-S

### **Asher Swivel Chair**

Outside: H34 W230 D34

Inside: H16.5 W21 D19

Seat: H20 Arm: H24



2712

### **Acacia Swivel Chair**

Outside: H35 W31 D36

Inside: H17 W20 D19

Seat: H19 Arm: H23



2692

### **Fallon Swivel Chair**

Outside: H38 W31 D34

Inside: H19 W20 D19

Seat: H19 Arm: H23



## SWIVEL CHAIRS



301-S

### **Avanti Swivel Chair**

Outside: H38.5 W31 D35  
Inside: H21 W20 D18.5-24  
Seat: H19.5 Arm: H23



540-S

### **Loxley Swivel Chair**

Outside: H38 W31.5 D39  
Inside: H20.5 W22.5 D19  
Seat: H19.5 Arm: H23

### **540-O Loxley Caster Ottoman**

Outside: H16 W27 D22.5



1652-SW

### **Soho Swivel Chair**

Outside: H34.5 W30.5 D35  
Inside: H17 W21 D22  
Seat: H18.5 Arm: H23

Also Available:  
1652 Chair (pg 86)



536-S

### **Wolfcreek Pass Swivel Chair**

Outside: H37.5 W30 D40  
Inside: H22 W21 D21  
Seat: H19.5 Arm: H25-23

## SWIVEL CHAIRS



450-GS

### **Saddlebrook Track Arm Glider Swivel Chair**

Outside: H38 W32 D39

Inside: H19 W22 D20

Seat: H19 Arm: H26

\*Complementary Caster Ottoman **450-O**



451-GS

### **Saddlebrook English Arm Glider Swivel Chair**

Outside: H38 W32 D39

Inside: H19 W22 D22

Seat: H19 Arm: H26

\*Complementary Caster Ottoman **451-O**



504-GS

### **Saddlebrook Tufted Glider Swivel Chair**

Outside: H40 W32.5 D36

Inside: H25.5 W20 D21-24

Seat: H19.5 Arm: H27.5

\*Complementary Caster Ottoman **504-O**



## SEAT SUSPENSION

Because you spend one third of your life on your mattress, you wouldn't consider anything less than coil springs for comfort and support that will last. We feel the same about our seat suspension. We employ steel coil springs for durability that are strategically placed and eight-way hand tied. This affords you deep seating comfort and is guaranteed for a lifetime. We never use synthetic or rubber straps which can deteriorate, sag or break. Our techniques and methods are time tested. Don't be misled by remarks such as "it's the latest European technology", etc. In most cases it's cheaper, not better. We are so confident our frames and springs will perform for as long as you own your piece of furniture.



## RECLINERS & VARI-TILTS

## RECLINERS & VARI-TILTS



287-RM

**Drayton Manual Recliner**

Outside: H42 W30 D39  
Inside: H23 W22 D21.5  
Seat: H20 Arm H23



583-VT

**Rathmines Vari-Tilt**

Outside: H41 W29.5 D38.5  
Inside: H26 W20.5 D23  
Seat: H19 Arm: H23-25

**583-O Rathmines Ottoman**

Outside: H17 W22 D20



582-VT

**Ranelagh Vari-Tilt**

Outside: H41 W29.5 D38.5  
Inside: H26 W23 D21.5  
Seat: H19 Arm: H23-24.5

**582-O Ranelagh Ottoman**

Outside: H17 W22 D20



1337POP

**Tucker Recliner w/ Pop-up Headrest**

Outside: H38 W32 D37  
Inside: H21 W21 D20  
Seat: H19 Arm: H23

Fully Reclined: 65  
Wall Clearance: 22  
Footrest: 19





## RECLINERS & VARI-TILTS



537-247

### **Oasis Recliner**

Outside: H43.5 W31 D37.5

Inside: H24.5 W21.5 D21.5

Seat: H19 Arm: H24

Fully Reclined: 66.5

Wall Clearance: 25

Footrest: 12



537-368P

### **Oasis Recliner w/ Power**

Outside: H44 W31 D37.5

Inside: H25 W21.5 D21.5

Seat: H19 Arm: H23.5

Fully Reclined: 66.5

Wall Clearance: 23.5

Footrest: 12



537-048P

### **Oasis Recliner w/ Power**

Outside: H43.5 W28.5 D37.5

Inside: H24.5 W21.5 D21.5

Seat: H19 Arm: H23

Fully Reclined: 66.5

Wall Clearance: 23

Footrest: 12



537-168PC

### **Oasis Recliner w/ Power & Chaise Pad**

Outside: H45 W31 D37.5

Inside: H25 W21.5 D21.5

Seat: H19 Arm: H23.5

Fully Reclined: 66.5

Wall Clearance: 23.5

Footrest: 12



## RECLINERS & VARI-TILTS



537-157

### **Oasis Recliner**

Outside: H42.5 W28.5 D36.5

Inside: H25 W21.5 D21.5

Seat: H19 Arm: H24

Fully Reclined: 66.5

Wall Clearance: 22

Footrest: 12



537-JDO

### **Oasis Recliner w/ Power**

Outside: H44 W30.5 D36.5

Inside: H25 W20 D22.5

Seat: H19.5 Arm: H24

Fully Reclined: 64

Wall Clearance: 19

Footrest: 13



537-IC7P

### **Oasis Recliner w/ Power**

Outside: H43 W28.5 D38

Inside: H24.5 W21 D22.5

Seat: H19.5 Arm: H24

Fully Reclined: 65

Wall Clearance: 21

Footrest: 12



537-HA7P

### **Oasis Recliner w/ Power**

Outside: H43.5 W31.5 D37

Inside: H24 W20.5 D21

Seat: H19.5 Arm: H24

Fully Reclined: 65

Wall Clearance: 21

Footrest: 12



# RECLINERS & VARI-TILTS



1387

**Phantom Recliner**

Outside: H45.5 W31 D39.5  
 Inside: H24.5 W21 D21  
 Seat: H20 Arm: H26.5

Fully Reclined: 68  
 Wall Clearance: 24  
 Footrest: 13



1397POP

**Winston Recliner w/ Pop-up Headrest**

Outside: H38 W30 D37.5  
 Inside: H18 W21.5 D21  
 Seat: H20 Arm: H23

Fully Reclined: 67  
 Wall Clearance: 23  
 Footrest: 17



1627

**Anna Recliner**

Outside: H41 W29 D37  
 Inside: H20 W22 D23  
 Seat: H20.5 Arm: H25

Fully Reclined:  
 Wall Clearance:  
 Footrest:



917-07

**Rhett Recliner**

Outside: H41 W38 D37  
 Inside: H22 W25 D21  
 Seat: H22 Arm: H25

Fully Reclined: 60  
 Wall Clearance:  
 Footrest: 21

*\*Motorized mechanism ONLY*

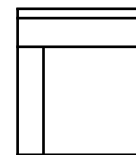

**917-07-1L**  
**Left Arm Recliner**  
 Outside: W31

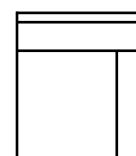

**917-07-1R**  
**Right Arm Recliner**  
 Outside: W31

*\*See Price Book for Standard Features*

## RECLINERS & VARI-TILTS



1757

### Cary Recliner

Outside: H44.5 W35.5 D36

Inside: H23 W22 D23

Seat: H20.5 Arm: H25

Fully Reclined: 67

Wall Clearance: 24



1447

### Laney Recliner

Outside: H41 W29.5 D41

Inside: H18.5 W23 D23

Seat: H22 Arm: H24.5

Fully Reclined: 70

Wall Clearance: 22

Footrest: 19



1607

### Greg Recliner

Outside: H42 W32 D36.5

Inside: H22 W22 D20

Seat: H19.5 Arm: H24

Fully Reclined: 65

Wall Clearance: 22



1377

### Woody Recliner

Outside: H41.5 W32 D38

Inside: H21 W22.5 D20

Seat: H20.5 Arm: H24

Fully Reclined: 66

Wall Clearance: 24

Footrest: 12



\*See Price Book for Standard Features



## RECLINERS & VARI-TILTS



531-RM

### **Barrington Manual Recliner**

Outside: H41 W29.5 D39.5

Inside: H23 W22 D21

Seat: H19.5 Arm: H24.5



533-RM

### **Barrineau Manual Recliner**

Outside: H41 W30 D39

Inside: H25 W22 D21

Seat: H19 Arm: H25



529-RM

### **Beaufort Manual Recliner**

Outside: H39.5 W34.5 D39.5

Inside: H21 W21.5 D21

Seat: H19.5 Arm: H24.5



1357

### **Dixie Recliner**

Outside: H39 W31 D41.5

Inside: H19 W22.5 D22

Seat: H20 Arm: H26.5

Fully Reclined: 66

Wall Clearance: 22

Footrest: 15



## RECLINERS & VARI-TILTS



284-SRM

### **Parkhurst Swivel Manual Recliner**

Outside: H42 W31.5 D38  
Inside: H26 W21.5 DS21.5  
Seat: H20 Arm: H24



285-SRM

### **Saxon Swivel Manual Recliner**

Outside: H42 W31.5 D38  
Inside: H26 W21.5 DS21.5  
Seat: H20 Arm: H24



439-VT

### **Camden Vari-Tilt Chair**

Outside: H39 W36 D40  
Inside: H21 W22 D21  
Seat: H18 Arm: H25

\*Complementary Ottoman **439-O**



440-VT

### **Rockport Vari-Tilt Chair**

Outside: H39 W36 D40  
Inside: H21 W22 D21  
Seat: H18 Arm: H25

### **440-O Rockport Ottoman**

Outside: H16 W28 D20



BEST SELLER

## RECLINERS & VARI-TILTS



530-RM

### Georgetown Manual Recliner

Outside: H40.5 W34.5 D39.5

Inside: H24 W21.5 D21

Seat: H19.5 Arm: H24



441-VT

### Cavendish Vari-Tilt

Outside: H38 W33 D40

Inside: H20 W20 D20

Seat: H18 Arm: H24



\*Complementary Ottoman **441-O**



528-RM

### Charleston Manual Recliner

Outside: H43 W34 D43

Inside: H27 W21.5 D20.5

Seat: H19.5 Arm: H24.5



576-RM

### Savannah Manual Recliner

Outside: H43 W34.5 D43

Inside: H26.5 W21.5 D19.5

Seat: H20 Arm: 24.5



## RECLINERS & VARI-TILTS



2677H

**Robinson High Back Recliner**

Outside: H37 W38 D39

Inside: H20 W21 D21

Seat: H20 Arm: H24

Fully Reclined: 64

Wall Clearance: 19

Footrest: 9



1027

**Forrest Recliner**

Outside: H43 W33 D35

Inside: H23 W21 D19

Seat: H20 Arm: H25

Fully Reclined:

Wall Clearance: 19

Footrest: 12

Also Available:

1027-19 Recliner

(Attached Back)



052H

**Bradley High Back Ease Back Chair**

Outside: H39 W34 D37

Inside: H22 W21 D18

Seat: H18 Arm: H22



052

**Bradley Ease Back Chair**

Outside: H36 W32 D42

Inside: H20 W22 D21

Seat: H19 Arm: H22

**1133 Bradley Ottoman**

Outside: H16 W29 D22



\*See Price Book for Standard Features



## RECLINERS & VARI-TILTS



042

### **Blayne Ease Back Chair**

Outside: H36 W35 D42

Inside: H18 W21 D21

Seat: H20 Arm: H23

### **1043 Blayne Ottoman**

Outside: H16 W29 D22

Also Available:

032 Ease Back Chair



1057-L

### **Bradley Recliner w/ Dual Motor Lift & Recline Mechanism**

Outside: H37 W33 D36

Inside: H20 W20 D20

Seat: H22 Arm: H23



1057SR

### **Bradley Swivel Glider Recliner**

Outside: H37 W33 D36

Inside: H20 W20 D20

Seat: H22 Arm: H23

Fully Reclined: 65

Wall Clearance: 16

Footrest: 14

Also Available:

1057 Recliner

1057R Glider Recliner



2057SRM

### **Mathis Heavy Duty Swivel Glider Recliner**

Outside: H43 W37.5 D38

Inside: H23 W24 D20

Seat: H20 Arm: H24

Fully Reclined: 67.5

Wall Clearance: 16

Footrest: 14

Also Available:

2057SR Mathis Heavy Duty

Swivel Glider Recliner

## RECLINERS & VARI-TILTS



2947SR

### Hale Swivel Glider Recliner

Outside: H40 W33 D40

Inside: H20 W21 D22

Seat: H21 Arm: H25

Fully Reclined: 67

Wall Clearance: 13

Footrest: 21 (from arm)

Also Available:

2947 Recliner

2947-L (w/ dual motor lift & recline mech)

2947R Glider Recliner



1367-SG

### Roth Swivel Glider Recliner

Outside: H41.5 W29 D40

Inside: H22.5 W20.5 D21

Seat: H19.5 Arm: H25.5

Fully Reclined: 69

Wall Clearance: 24

Footrest: 20



2427

### Virgil Recliner

Outside: H40 W36 D39

Inside: H19 W21 D23

Seat: H21 Arm: H25

Fully Reclined: 66

Wall Clearance: 20

Footrest: 9 (from arm)



## RECLINERS

Our motion seating was designed for a single purpose ~ *relaxation*. Form and function combine to create a product that is reliable and handsome. As with all of our seating, the frame is constructed of kiln dried hardwood. Every component is manufactured to the exact specifications required by each mechanism, coil spring suspension and premium seat cushions assure comfort and enduring service. This is the gift that every successful person deserves. For your benefit, we have added our matching leather covered handle as a standard feature on select styles.

## RECLINERS & VARI-TILTS



2407

### **Conner Recliner**

Outside: H41 W39 D42

Inside: H20 W22 D24

Seat: H21 Arm: H25

Fully Reclined:

Wall Clearance: 15

Footrest: 14



402

### **Conner Ease Back Chair**

Outside: H41 W40 D40

Inside: H21 W21 D24

Seat: H19 Arm: H25

### **2403 Conner Ottoman**

Outside: H16 W28 D21

Also Available:

2403-3 Ottoman



297-07

### **Helen Recliner**

Outside: H38 W29 D36

Inside: H20 W20 D22

Seat: H20 Arm: H23

Fully Reclined: 61

Wall clearance: 14

Footrest: 10

Also Available:

297-07H Recliner



397-07

### **Helen Recliner**

Outside: H40 W34 D38

Inside: H25 W23 D22

Seat: H19 Arm: H23

Fully Reclined: 62

Wall clearance: 16

Footrest: 10





SOFAS & LOVESEATS



## SOFAS & LOVESEATS



926-00

### **Cloud Nine Sofa**

Outside: H35 W85 D38  
Inside: H14.5 W71 D22  
Seat: H20.5 Arm: H27.5



912-00/108

### **Maxine Sofa**

Outside: H36.5 W108 D40  
Inside: H17 W92 D22  
Seat: H19.5 Arm: H24

Also Available:  
912-00/96 96" Sofa  
912-00/84 84" Sofa



3440-117

### **Rockies Sofa**

Outside: H34.5 W117 D39  
Inside: H15.5 W105 D22  
Seat: H19 Arm: H29.5



## SOFAS & LOVESEATS



1630

### **Kensington Sofa**

Outside: H37 W73 D37

Inside: H16 W65 D22

Seat: H21 Arm: H25



613-88

### **Madison Sofa**

Outside: H36.25 W88 D39

Inside: H17 W73 D24

Seat: H20.5 Arm: H31.5



289-94

### **Anaheim Sofa**

Outside: H34 W95 D42.5

Inside: H21 W87 D24.5

Seat: H20.5 Arm: H22



406-94

### **Augustine Sofa**

Outside: H40 W96 D42

Inside: H18.5 W88 D22

Seat: H23 Arm: H24

## SOFAS & LOVESEATS



558-83

### **Findlay Sofa**

Outside: H37 W83 D38.5

Inside: H19 W77 D22

Seat: H19 Arm 23.5

\*Complementary Loveseat **558-57**



599-83

### **Pascal Sofa**

Outside: H37 W83 D.38.5

Inside: H19 W77 D22

Seat: H19 Arm: H24.5

\*Complementary Loveseat **599-57**



933-00

### **Shelly Sofa**

Outside: H38.5 W88 D40

Inside: H16 W75 D23

Seat: H20.5 Arm: H23.5



2630

### **Breckenridge Sofa**

Outside: H36 W85 D37

Inside: H15 W74 D23

Seat: H21 Arm: H24

Also Available:  
2635 Loveseat  
2632 Chair  
2633 Ottoman

## SOFAS & LOVESEATS



432-80

**Richardson Ave Sofa**

Outside: H35 W80 D41

Inside: H16 W70 D21

Seat: H19 Arm: H25

\*Complementary Loveseat **432-58**



565-90

**Auburn Sofa**

Outside: H34 W90 D38

Inside: H19.5 W68.5 D22.5

Seat: H20 Arm: H34



560-90

**Doyle Sofa**

Outside: H32 W90 D39

Inside: H14.5 W68 D23

Seat: H18 Arm: H32.5



593-98

**Orleans Sofa**

Outside: H34 W98 D38

Inside: H17 W80 D21.5

Seat: H19.5 Arm: H26

\*Complementary Loveseat **593-71**



## SOFAS & LOVESEATS



303-84

### **Garrison Sofa**

Outside: H37 W84.5 D37

Inside: H18 W72 D19

Seat: H19.5 Arm: H24

\*Complementary Loveseat **303-60**



304-84

### **Keighley Sofa**

Outside: H37 W83 D37

Inside: H18 W72 D20

Seat: H19.5 Arm: H24.5-26.5

\*Shown in Optional Waterfall Skirt  
(Available with Upcharge)

\*Complementary Loveseat **304-60**



305-84

### **Leeds Sofa**

Outside: H35.5 W83 D37

Inside: H18 W73 D19

Seat: H19.5 Arm: H25.5

\*Complementary Loveseat **305-60**



306-84

### **Shelby Sofa**

Outside: H37 W84.5 D37

Inside: H18 W72 D20

Seat: H19.5 Arm: H24

\*Complementary Loveseat **306-60**

## SOFAS & LOVESEATS



705-52

### **Andover Settee**

Outside: H34 W52 D33.5  
Inside: H19.5 W48.5 D23.5  
Seat: H20.5 Arm: H24

\*Complementary Chair **705**



499-66

### **Hayley Loveseat**

Outside: H38 W67 D33  
Inside: H17.5 W59 D20.5  
Seat: H22 Arm: H25.5



404-64

### **Halifax Settee**

Outside: H38 W64 D33  
Inside: H19 W64 D20  
Seat H22.5

\*Complementary Chair **404**, Armless  
Chair **404-32**, & Ottoman **404-O**

"IF WE LEARN TO BUILD  
WITH LOCAL MATERIALS,  
WE HAVE A FUTURE"

- Francis Kéré



## SOFAS & LOVESEATS



568-89

### French Salon Sofa

Outside: H36 W89 D38.5

Inside: H18 W79-76 D21

Seat: H19 Arm: H25

\*Complementary Loveseat **568-63**



592-88

### Piccadilly Loft Sofa

Outside: H36 W88 D37

Inside: H16.5 W77 D21

Seat: H19 Arm: H27



592-80

### Piccadilly Loft Apartment Sofa

Outside: H36 W80 D37

Inside: H16.5 W69 D21

Seat: H19 Arm: H27



592-61

### Piccadilly Loft Loveseat

Outside: H36 W61 D37

Inside: H16.5 W50 D21

Seat: H19 Arm: H27

BEST SELLER



## SOFAS & LOVESEATS



277-94

### **Peyton Sofa**

Outside: H36 W94 D40.5

Inside: H21 W86 D22.5

Seat: H18 Arm: H22

\*Complementary Loveseat **277-66**



278-94

### **Reilly Sofa**

Outside: H36 W94 D40.5

Inside: H21 W84 D22.5

Seat: H18 Arm: H22.5

\*Complementary Loveseat **278-66**



579-91

### **Carmichael Sofa**

Outside: H37 W91 D40

Inside: H18 W77 D19

Seat: H19 Arm: H26

\*Complementary Loveseat **579-65**



579-81

### **Carmichael Apartment Sofa**

Outside: H37 W81 D40

Inside: H18 W67 D19

Seat: H19 Arm: H26



## SOFAS & LOVESEATS



398-80

### **Talbot Sofa**

Outside: H37 W80 D39

Inside: H18 W67 D20

Seat: H19 Arm: H24

\*Complementary Loveseat **398-57**



437-80

### **Carlisle Sofa**

Outside: H34 W80 D40

Inside: H16 W65 D23

Seat: H18 Arm: H26

\*Complementary Loveseat **437-58**



526-79

### **Braidwood Sofa**

Outside: H36 W79 D43

Inside: H18 W68 D21

Seat: H19 Arm: H24

\*Complementary Loveseat **526-54**



1870

### **Jennings Sofa**

Outside: H41 W83 D40.5

Inside: H20.5 W71.5 D28

Seat: H21 Arm: H24

\*Shown with optional #54 nails

## SOFAS & LOVESEATS



524-83

### **Lindsay Sofa**

Outside: H37 W83 D40.5

Inside: H19 W75 D21

Seat: H21 Arm: H25

\*Complementary Loveseat **524-58**



410-80

### **Farrington Sofa**

Outside: H37 W80 D39

Inside: H18 W67 D20

Seat: H19 Arm: H24

\*Complementary Loveseat **410-57**



547-91

### **Bingeborough Sofa**

Outside: H40 W91 D41

Inside: H21 W80 D23

Seat: H22 Arm: H23

\*Complementary Loveseat **547-64**



548-91

### **Devonshire Sofa**

Outside: H37 W91 D42.5

Inside: H19 W80 D23

Seat: H18.5 Arm: H23.5

\*Complementary Loveseat **548-64**

## SOFAS & LOVESEATS



409-80

### Holborn Sofa

Outside: H34 W80 D41

Inside: H16 W66 D22

Seat: H18 Arm: H23

\*Complementary Loveseat **409-58**



390-83

### Bishopsgate Sofa

Outside: H38 W83 D42

Inside: H20 W68 D22

Seat: H18 Arm: H25

\*Complementary Loveseat **390-60**



510-83

### Finsbury Sofa

Outside: H38.5 W83 D41

Inside: H20 W69 D20.5

Seat: H19 Arm: H26.5

\*Complementary Loveseat **510-60**



3330

### Logan Sofa

Outside: H35 W92 D40

Inside: H17 W66 D25

Seat: H20 Arm: H28

Also Available:

3332 Chair

3335 Loveseat

3330 Series Sectional

3330-68S Sleeper Sofa

3333 Ottoman

BEST SELLER



## SOFAS & LOVESEATS



2670

**Robinson Sofa**

Outside: H35 W83 D39

Inside: H16 W67 D21

Seat: H19 Arm: H24

Also Available:  
2675 Loveseat  
672 Ease Back  
2672 Chair  
2673 Ottoman



2560

**Garland Sofa**

Outside: H39 W89 D41

Inside: H19 W72 D22

Seat: H20 Arm: H24

Also Available:  
2565 Loveseat  
2562 Chair  
2653 Ottoman



1960

**Livingston Sofa**

Outside: H37 W81 D39

Inside: H16 W66 D23

Seat: H20 Arm: H27

Also Available:  
1965 Loveseat  
1962 Chair  
1963 Ottoman



2530

**Montana Sofa**

Outside: H38 W83 D37

Inside: H17 W64 D22

Seat: H21 Arm: H26

Also Available:  
2535 Loveseat  
2532 Chair  
2533 Ottoman



## SOFAS & LOVESEATS



2380-88

### **Pearce Sofa**

Outside: H36 W76 D38

Inside: H19 W61 D23

Seat: H20 Arm: H26



2380

### **Pearce Sofa**

Outside: H36 W76 D38

Inside: H19 W61 D23

Seat: H20 Arm: H26



454-78

### **MiddlePark Sofa**

Outside: H38 W78 D41

Inside: H19 W65 D21

Seat: H20 Arm: H26



454-55

### **MiddlePark Loveseat**

Outside: H38 W55 D41

Inside: H19 W42 D21

Seat: H20 Arm: H26

## SOFAS & LOVESEATS



441-87

**Cavendish Sofa**

Outside: H38 W87 D40.5

Inside: H18.5 W73 D20.5

Seat: H20 Arm: H24

\*Complementary Loveseat **441-62**



435-106

**Aldersgate Sofa**

Outside: H38 W106 D45

Inside: H20 W88 D24

Seat: H18 Arm: 26



435-89

**Aldersgate Sofa**

Outside: H38 W89 D45

Inside: H20 W71 D24

Seat: H18 Arm: 26



435-64

**Aldersgate Loveseat**

Outside: H38 W64 D45

Inside: H20 W46 D24

Seat: H18 Arm: 26

BEST SELLER

## SOFAS & LOVESEATS



2120/90-18

### Wakefield Sofa

Outside: H31 W90 D37

Inside: H14 W68 D22

Seat: H20 Arm: H31

Also Available:

2125-18 Wakefield Loveseat

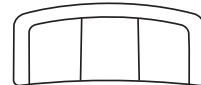

2070-88-38

### Churchill Long Sofa

Outside: H29 W88 D36

Inside: H14 W72 D22

Seat: H18 Arm: H27

Also Available:

2070-68S Sleeper

2072-38 Chair



2070-76-38

### Churchill Sofa

Outside: H29 W76 D36

Inside: H14 W60 D22

Seat: H18 Arm: H27



2070-67-38

### Churchill Short Sofa

Outside: H29 W67 D36

Inside: H14 W51 D22

Seat: H18 Arm: H27



## SOFAS & LOVESEATS

BEST SELLER



1010

### St. Lucia Sofa

Outside: H37 W88 D42

Inside: H16 W69 D23

Seat: H21 Arm: H26

Also Available:

1015 Loveseat

1012 Chair

1013 Ottoman



527-86

### Stanhope Chesterfield Sofa

Outside: H32 W85.5 D37

Inside: H16 W64 D24

Seat: H19.5 Arm: H32

\*Complementary Loveseat **527-61**



537-86

### Stanhope Chesterfield Bench Seat Sofa

Outside: H32 W85.5 D37

Inside: H16 W64 D24

Seat: H19.5 Arm: H32

\*Complementary Loveseat **537-61**



555-90

### Poppins Court Sofa

Outside: H32.5 W89 D39

Inside: H18 W68 D22-23

Seat: H19 Arm: H32.5

\*Complementary Apartment Sofa **555-73**



## SOFAS & LOVESEATS



525-83

### **Dowgate Hill Sofa**

Outside: H37 W83 D41

Inside: H19 W73.5 D21

Seat: H20 Arm: H27



525-58

### **Dowgate Hill Loveseat**

Outside: H37 W58 D41

Inside: H19 W48.5 D21

Seat: H20 Arm: H27



562-94

### **Waitman Sofa**

Outside: H39 W94 D45

Inside: H20 W81 D21

Seat: H21 Arm: H25-24

\*Complementary Loveseat **562-66**

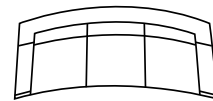

562-122

### **Waitman Four Seat Sofa**

Outside: H39 W122 D45

Inside: H20 W109 D21

Seat: H21 Arm: H24-25

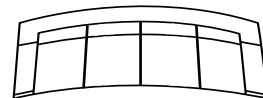



## SECTIONALS

# SECTIONALS

## Maxine



912-08/16

### Left Arm Sofa

Outside: H35 W37.5 D69  
Inside: H16 W30 D54  
Seat: H18.5 Arm: H24

912-00-1R

### Right Arm Sofa

Outside: H35 W89 D40  
Inside: H16 W80.5 D22.5  
Seat: H18.5 Arm: H24

912-08/15

### Right Arm Sofa

Outside: H35 W37.5 D69  
Inside: H16 W30 D54  
Seat: H18.5 Arm: H24

912-00-1L

### Left Arm Sofa

Outside: H35 W89 D40  
Inside: H16 W80.5 D22.5  
Seat: H18.5 Arm: H24



# SECTIONALS

## Rockies



3440-1R

**Right Arm Sofa**

Outside: H34.5 W76.5 D39  
Inside: H15.5 W70.5 D22  
Seat: H19 Arm: H29.5

3442-35

**Corner Chair**

Outside: H34.5 W40.5 D39  
Inside: H15.5 W22.5 D22  
Seat: H19

3442-10

**Armless Chair**

Outside: H34.5 W35.5 D39  
Inside: H15.5 W35.5 D22  
Seat: H19

3440-1L

**Left Arm Sofa**

Outside: H34.5 W76.5 D39  
Inside: H15.5 W70.5 D22  
Seat: H19 Arm: H29.5

3444

**Ottoman**

Outside: H19 W37.5 D37.5





# SECTIONALS

## Palmyra



407-RAF

**Right Arm Section**

Outside: H32 W43.5 D40  
Inside: H13 W33 D20  
Seat H19 Arm H22.75



407-33

**Armless Chair**

Outside: H32 W33.5 D40  
Inside: H13 W33.5 D20  
Seat H19



407-CR

**Corner Chair**

Outside: H32 W40 D40  
Inside: H13 W33 D33  
Seat H19



407-LAF

**Left Arm Section**

Outside: H32 W43.5 D40  
Inside: H13 W33 D20  
Seat H19 Arm H22.75



407-O

**Ottoman**

Outside: H17 W34 D40

# SECTIONALS

## Parkshore



400-52 LAF

**Left Arm Section**

Outside: H34 W52 D42  
 Inside: H15 W42 D18-26  
 Seat: H20.5 Arm: H26

400-42

**Armless Chair**

Outside: H34 W42 D42  
 Inside: H15 W42 D18-26  
 Seat: H20.5

400-52 RAF

**Right Arm Section**

Outside: H34 W52 D42  
 Inside: H15 W42 D18-26  
 Seat: H20.5 Arm: H26

400-O

**Ottoman**

Outside: H17.5 W42 D42

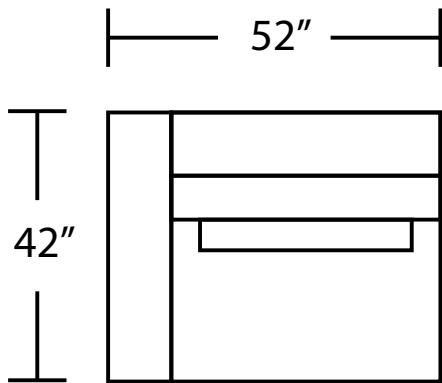

400-52 LAF

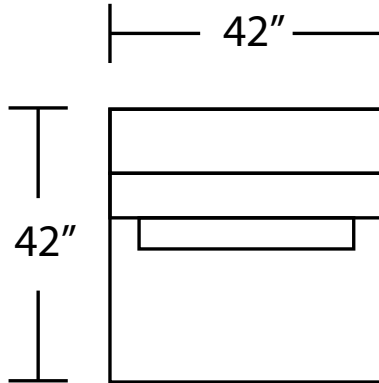

400-42 Armless

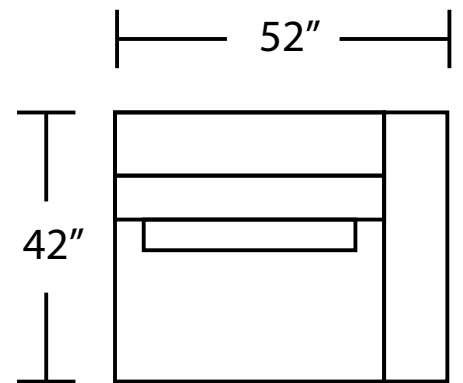

400-52 RAF

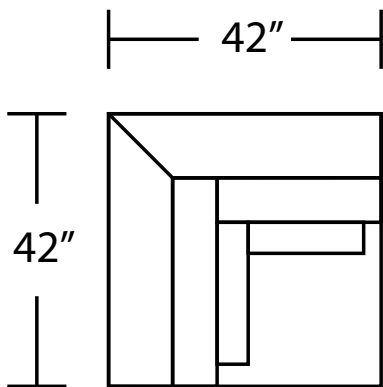

400-CR Corner

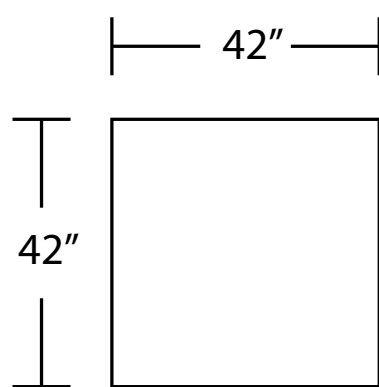

400-O Ottoman

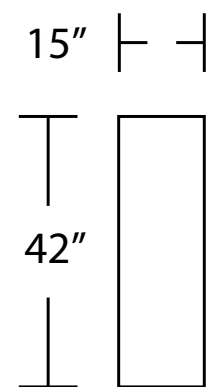

400-15 Floating Arm

\*Drawings not to scale

\*See Price Book for Standard Features

# SECTIONALS

## Peyton



277-32 LAF

**Left Arm Section**

Outside: H36 W32 D40  
 Inside: H21 W29 D23  
 Seat: H18 Arm: H22

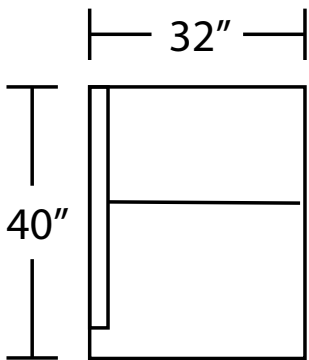

277-32 LAF

277-28

**Armless Chair**

Outside: H36 W28 D40  
 Inside: H21 W28 D23  
 Seat: H18

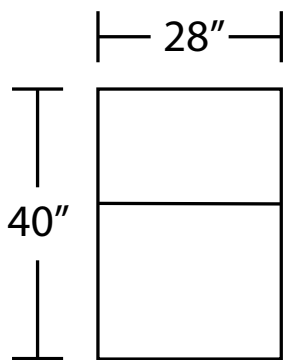

277-28 Armless

277-40

**Corner Chair**

Outside: H36 W40 D40  
 Inside: H21 W23 D23  
 Seat: H18

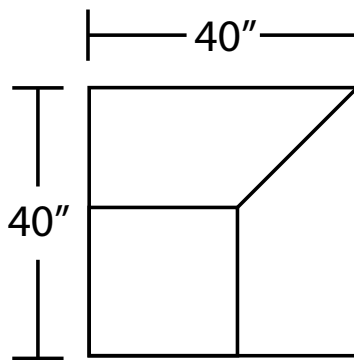

277-40 Corner

277-32 RAF

**Right Arm Section**

Outside: H36 W32 D40  
 Inside: H21 W29 D23  
 Seat: H18 Arm: H22

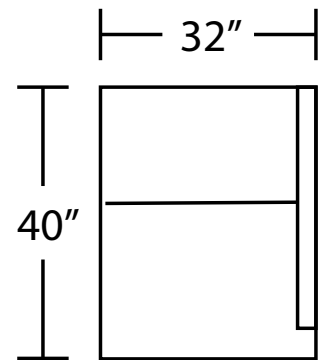

277-32 RAF

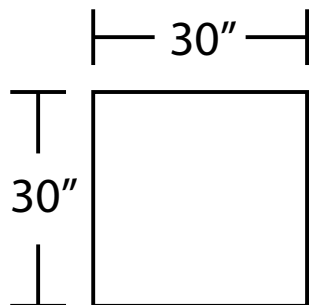

277-30 Ottoman



# SECTIONALS

## Reilly



278-32 LAF

**Left Arm Section**

Outside: H36 W32 D40  
 Inside: H21 W23 D23  
 Seat: H18 Arm: H22

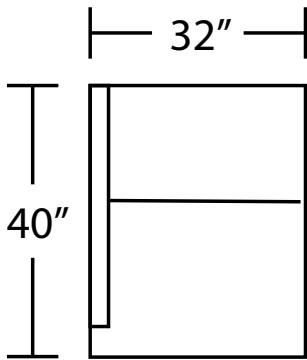

278-32 LAF

278-28

**Armless Chair**

Outside: H36 W28 D40  
 Inside: H21 W28 D23  
 Seat: H18

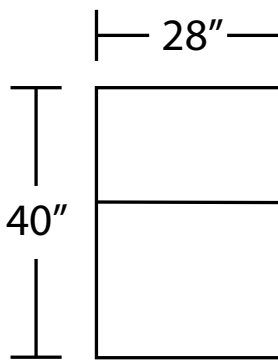

278-28 Armless

278-40

**Corner Chair**

Outside: H36 W40 D40  
 Inside: H21 W23 D23  
 Seat: H18

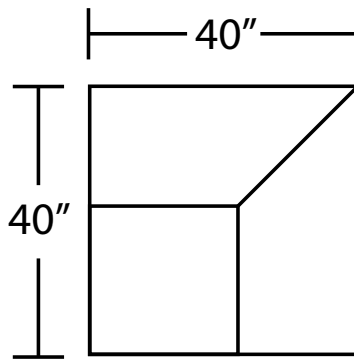

278-40 Corner

278-32 RAF

**Right Arm Section**

Outside: H36 W32 D40  
 Inside: H21 W23 D23  
 Seat: H18 Arm: H22

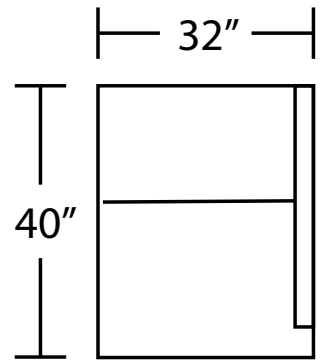

278-32 RAF

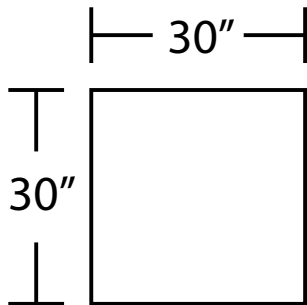

278-30 Ottoman



\*Drawings not to scale



# SECTIONALS

## Shelly



933-05-1L

**Left Arm Loveseat**

Outside: H38.5 W57 D40

Inside: H16 W52 D23

Seat: H20.5 Arm: H23.5

933-00R

**Right Arm Loveseat**

Outside: H38.5 W97 D40

Inside: H16 W74.5 D23

Seat: H20.5 Arm: H23.5



MADE BY THE  
HANDS OF ARTISANS

# SECTIONALS

## Braidwood



526-80 LAF

526-96 RAF

### Left Arm Section

Outside: H36 W80 D42  
 Inside: H18 W67 D22  
 Seat: H19 Arm: H24

### Right Arm Corner Section

Outside: H36 W96 D42  
 Inside: H18 W72 D22  
 Seat: H19 Arm: H24

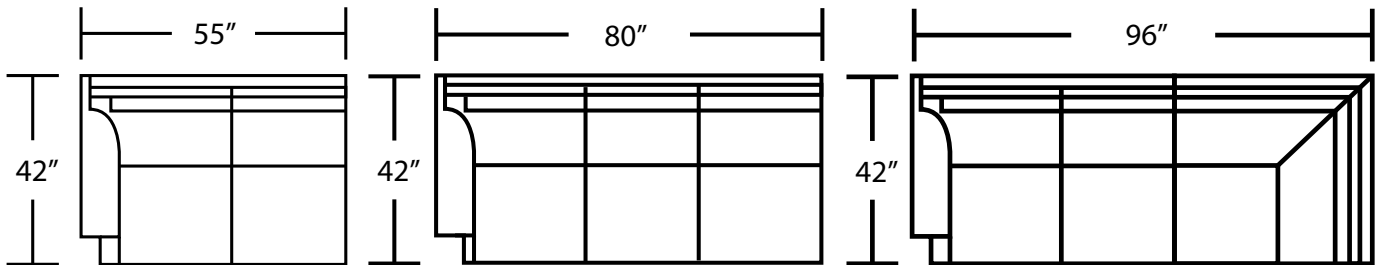

526-55 LAF

526-80 LAF

526-96 LAF Corner Sofa

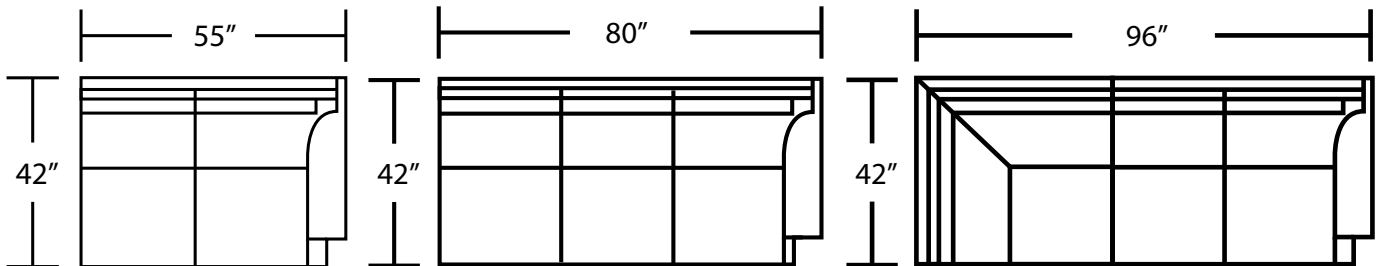

526-55 RAF

526-80 RAF

526-96 RAF Corner Sofa

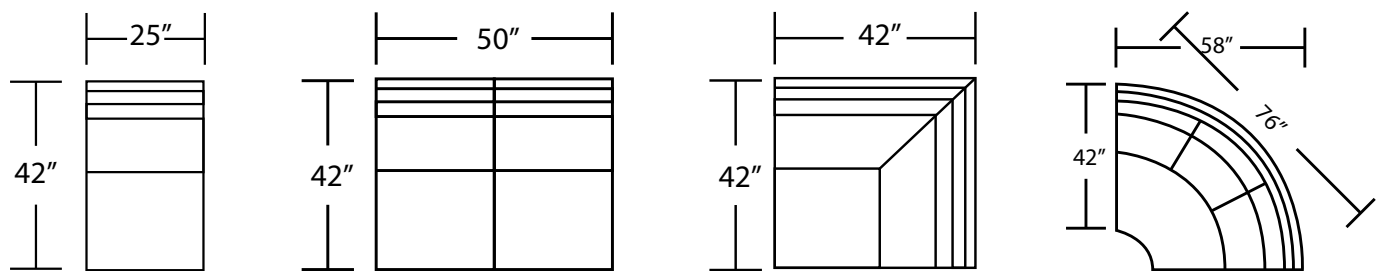

526-25 Armless

526-50 Armless Loveseat

526-42 Corner

526-76W Wedge

# SECTIONALS

## Finsbury



510-57 LAF

**Left Arm Loveseat**

Outside: H38.5 W57 D41  
 Inside: H20 W50 D20.5  
 Seat : H19 Arm: H26.5

510-76W

**Wedge**

Outside: H38.5 W21-76 D41  
 Inside: H20 W21-50 D20.5  
 Seat: H19

510-25

**Armless**

Outside: H38.5 W25 D41  
 Inside: H20 W25 D20.5  
 Seat: H19 Arm: H26.5

510-70 RAF

**Right Arm Chaise**

Outside: H38.5 W43 D70  
 Inside: H20 W35.5 D50  
 Seat: H19 Arm: H26.5

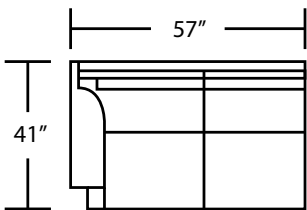

510-57 LAF

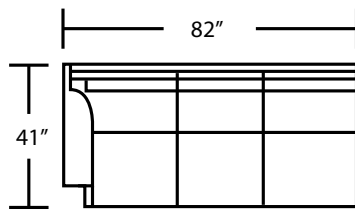

510-82 LAF

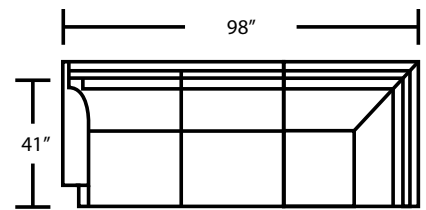

510-98 LAF

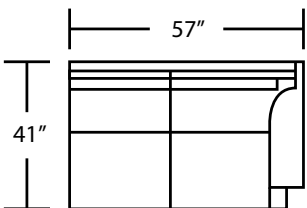

510-57 RAF

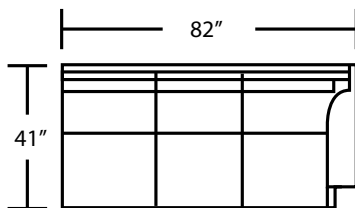

510-82 RAF

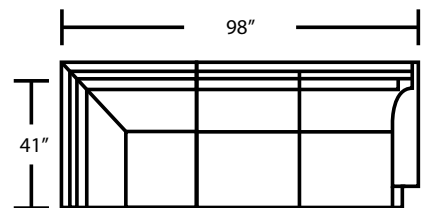

510-98 RAF

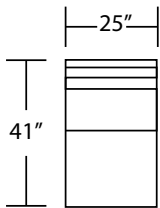

510-25 Armless

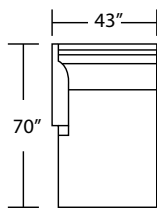

510-70 LAF Chaise

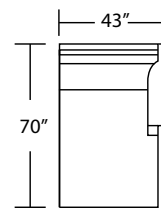

510-70 RAF Chaise

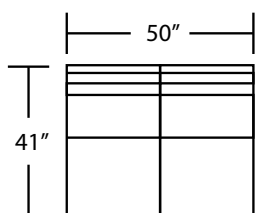

510-50 Armless Loveseat

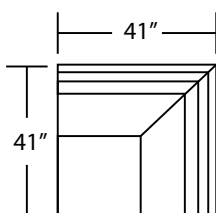

510-42 Corner

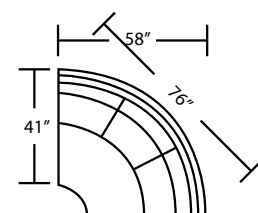

510-76W Wedge

# SECTIONALS

## Aldersgate



435-113 LAF

**Left Arm Corner Section**

Outside: H38 W113 D45

Inside: H20 W85 D24

Seat: H18 Arm: 26

435-31

**Ottoman**

Outside: H16 W31 D31

435-68 RAF

**Right Arm Loveseat**

Outside: H38 W68 D45

Inside: H20 W61 D24

Seat: H28 Arm: H26

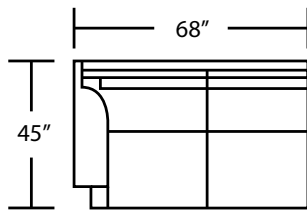

435-68 LAF

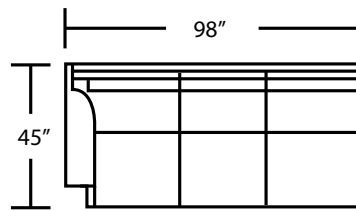

435-98 LAF

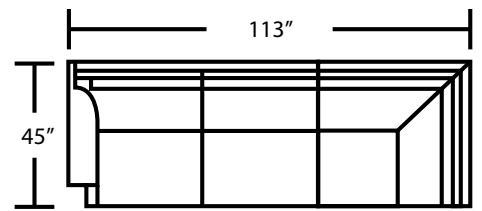

435-113 LAF

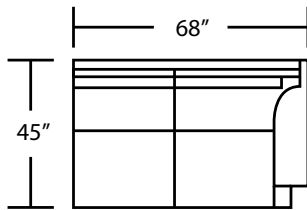

435-68 RAF

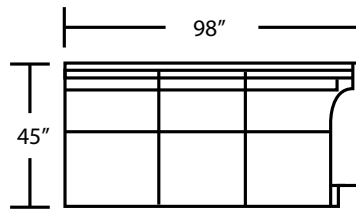

435-98 RAF

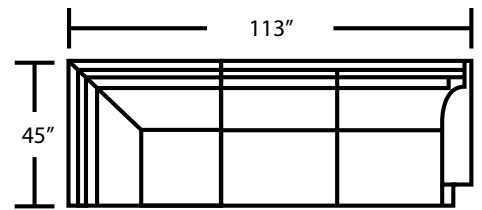

435-113 RAF

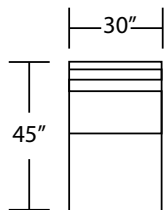

435-30 Armless

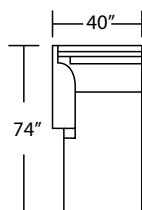

435-74 LAF Chaise

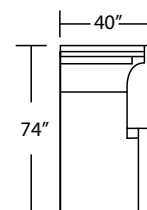

435-74 RAF Chaise

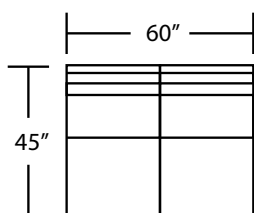

435-60 Armless Loveseat

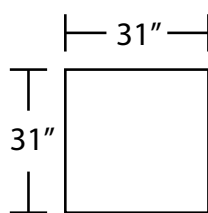

435-31 Ottoman

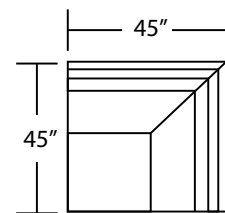

435-45 Corner

\*Drawings not to scale

\*See Price Book for Standard Features



# SECTIONALS

## Logan



3339

3335-1L

3335-1R



— 23 —

**3332-10 Armless Chair**  
H35 W23 D40  
Inside: H17 W23 D25  
Seat H: 20

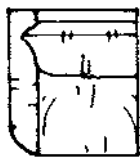

— 33 —

**3332-21 Left Arm Chair**  
H35 W33 D40  
Inside: H17 W21 D25  
Seat H: 20 Arm H: 28



— 33 —

**3332-20 Right Arm Chair**  
H35 W33 D40  
Inside: H17 W21 D25  
Seat H: 20 Arm H: 28

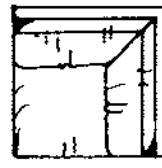

— 40 —

**3332-35 Corner**  
H35 W40 D40  
Inside: H17 W21 D25  
Seat H: 20

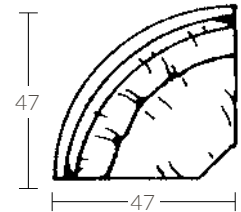

47

— 47 —

**3339 Wedge**  
H35 W66 D43  
Inside: H17 W42 D25  
Seat H: 20

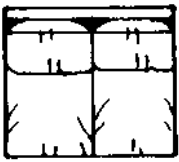

— 46 —

**3335-46 Armless Loveseat**  
H35 W46 D40  
Inside: H17 W46 D25  
Seat H: 20

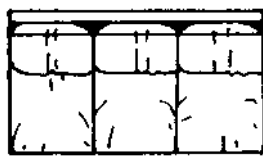

— 70 —

**3330-70 Armless Sofa**  
H35 W70 D40  
Inside: H17 W70 D25  
Seat H: 20

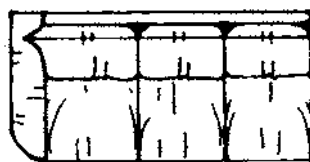

— 81 —

**3330-1L Left Arm Sofa**  
H35 W81 D40  
Inside: H17 W68 D25  
Seat H: 20 Arm H: 28

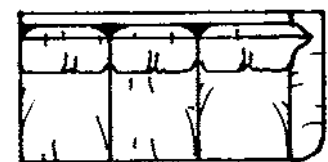

— 81 —

**3330-1R Right Arm Sofa**  
H35 W81 D40  
Inside: H17 W68 D25  
Seat H: 20 Arm H: 28

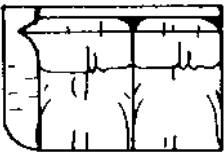

— 56 —

**3335-1L Left Arm Loveseat**  
H35 W56 D40  
Inside: H17 W43 D25  
Seat H: 20 Arm H: 28



— 56 —

**3335-1R Right Arm Loveseat**  
H35 W56 D40  
Inside: H17 W43 D25  
Seat H: 20 Arm H: 28



— 94 —

**3330L Left Arm/Corner Right Sofa**  
H35 W94 D40  
Inside: H17 W65 D25  
Seat H: 20 Arm H: 28



— 94 —

**3330R Right Arm/Corner Left Sofa**  
H35 W94 D40  
Inside: H17 W65 D25  
Seat H: 20 Arm H: 28

# SECTIONALS

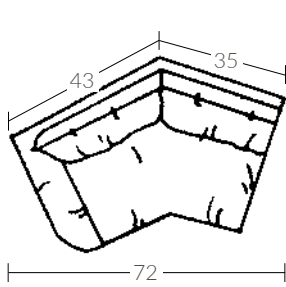

**3335-50-1L**  
**Left Arm Angled Loveseat**  
 H35 W72 D40  
 Inside: H17 W48 D25  
 Seat H: 20 Arm H: 28

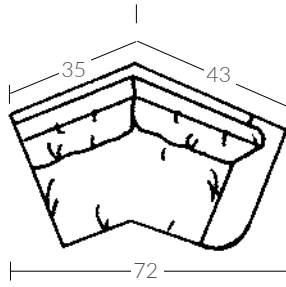

**3335-50-1R**  
**Right Arm Angled Loveseat**  
 H35 W72 D40  
 Inside: H17 W48 D25  
 Seat H: 20 Arm H: 28

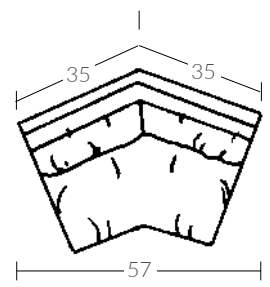

**3335-50**  
**Angled Loveseat**  
 H35 W57 D40  
 Inside: H17 W48 D25  
 Seat H: 20 Arm H: 28

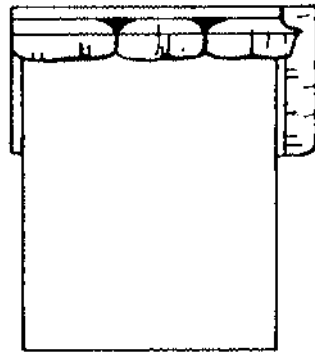

**3330-68S-1R**  
**Right Arm Sleeper**  
 H35 W81 D40  
 Inside: H17 W68 D25  
 Seat H: 20 Arm H: 28

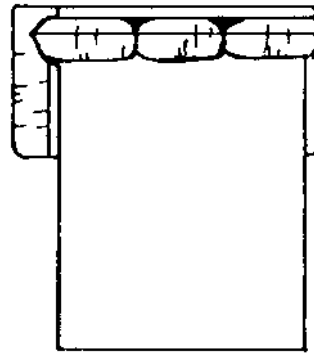

**3330-68S-1L**  
**Left Arm Sleeper**  
 H35 W81 D40  
 Inside: H17 W68 D25  
 Seat H: 20 Arm H: 28





BENCHES &  
ACCENT OTTOMANS

## BENCHES & ACCENT OTTOMANS



914-O

### **Carmel Sling Ottoman**

Outside: H19.5 W24 D23

\*Standard Finish: Brushed Brass

\*Custom powdercoat finish can be applied.  
Call office for details.

\*Complementary Chair **914**



915-O

### **Wrenn Sling Rocking Ottoman**

Outside: H17 W25 D21

\*Standard Finish: Brushed Brass

\*Custom powdercoat finish can be applied.  
Call office for details.

\*Complementary Chair **915-RK**



773-O

### **Basalt Ottoman**

Outside: H15 W18 D18



798-O

### **Trilogy Nesting Cocktail Ottoman**

Outside: H20 W48 D24.5

Inside: (2) H15 W22 D18



# BENCHES & ACCENT OTTOMANS



513

**Poppy Ottoman**

Outside: H19 W19 D19



513C

**Poppy Ottoman with Casters**

Outside: H19 W19 D19



523

**Portia Ottoman**

Outside: H18 W22 D22

Individualize your style with one of over 200 leather options...  
You imagine, we create!

BEST SELLER

## BENCHES & ACCENT OTTOMANS



513-30C

**Poppy Ottoman w/ Recessed Casters**

Outside: H19 W30 D30



524

**Rebecca Ottoman**

Outside: H17 W42 D42



911-04

**Beaufort Ottoman**

Outside: H19 W60 D37



403

**Julius Bench**

Outside: H20 W63 D20

## BENCHES & ACCENT OTTOMANS



770C-O

**Chiclet Bunching Cube with Casters**

Outside: H17 W17 D17



762-O

**Chiclet Bunching Cube**

Outside: H19 W17 D17

\*Also Available **769-O** Flange Chiclet Cube



553-18

**Neon Ottoman**

Outside: H19 W18 D18



553

**Neon Ottoman**

Outside: H18 W28 D16

## BENCHES & ACCENT OTTOMANS



797-O

**Xander Bunching Bench**

Outside: H21.5 W20.5 D18



700-O

**Swaggy Bunching Ottoman**

Outside: H20 W23 D18.5



744-OP

**Friars Bunching Bench with Platinum Base**

Outside: H19.5 W22.5 D20

\*Also Available in **744-OAB** Bronze Leg



745-OP

**Friars Hall Bench with Platinum Base**

Outside: H20 W48 D20

\*Also Available in **745-OAB** Bronze Leg





## BENCHES & ACCENT OTTOMANS



404-O

**Halifax Ottoman**

Outside: H21.5 W32 D32



891-O

**Cardiff Cocktail Ottoman**

Outside: H20 Dia38.5



742-O

**Wexford Circle Cocktail Ottoman**

Outside: H20 Dia39



767-O

**Wexford Place Bench**

Outside: H19 W53.5 D18.5

## BENCHES & ACCENT OTTOMANS



733C-O

**Ellipsis Caster Bunching Ottoman**

Outside: H17.5 W30 D19



733-O

**Ellipsis Bunching Ottoman**

Outside: H17.5 W30 D19



736C-O

**Ellipsis Banded Caster Bunching Ottoman**

Outside: H17.5 W30 D19



736-O

**Ellipsis Banded Bunching Ottoman**

Outside: H17.5 W30 D19

## BENCHES & ACCENT OTTOMANS



534

**Brigham Ottoman**  
Outside: H16 Dia30.5



584-36

**Brigham Ottoman**  
Outside: H16 Dia36



584JB

**Sensation Ottoman**  
Outside: H16 Dia30.5



## BENCHES & ACCENT OTTOMANS



890C-O

**Honeycomb Cocktail Ottoman**

Outside: H20.5 Dia46



895C-O

**Honeycomb Skirted Ottoman**

Outside: H20.5 Dia46



892C-O

**Continuation Caster Cocktail Ottoman**

Outside: H19.5 Dia38.5

\*Also Available **892-O** Bench



893-O

**Continuation Cocktail Ottoman with Tufted Top**

Outside: H19.5 Dia38.5

\*Also Available **893C-O** Caster Bench



# BENCHES & ACCENT OTTOMANS

BEST SELLER



918-04/RD1

**Vivian Ottoman**

Outside: H14 W48 D48

Also Available:

918-04/RD2 Ottoman

Outside: H14 W36 D36

918-04/RD3 Ottoman

Outside: H14 W24 D24



916-04/SQ1

**Studio Ottoman**

Outside: H14 W48 D48

Also Available:

916-04/SQ3 Ottoman

Outside: H14 W48 D24

916-04/SQ4 Ottoman

Outside: H14 W36 D36

916-04/SQ5 Ottoman

Outside: H14 W36 D24

916-04/SQ6 Ottoman

Outside: H14 W24 D24

\*Optional legs available. Call office for details.



916-04/SQ2

**Studio Ottoman**

Outside: H14 W48 D36

## BENCHES & ACCENT OTTOMANS



852-O

**Trotter Bench**

Outside: H17 W26 D26



851-O

**Trotter Bench with Hand Tufted Top**

Outside: H17 W26 D26



707-O

**Eastbourne Bench**

Outside: H17 W43 D23.5



703-O

**Dover Court Bench**

Outside: H16.5 W54 D33

## BENCHES & ACCENT OTTOMANS



748-O

**Hyde Park Cocktail Ottoman**

Outside: H19.5 W42 D42



728-TO

**Hyde Park Tray Cocktail Ottoman**

Outside: H20 W42 D42

Tray: W22.5 D22.5



894-O

**Emsworth Button Top Bench**

Outside: H21.5 W49 D36



884-TO

**Emsworth Tray Cocktail Ottoman**

Outside: H21.5 W49 D36

Tray: W13.5 D26.5

## BENCHES & ACCENT OTTOMANS



849-O

**Billingsly Bench**

Outside: H18 W52 D28



883-O

**Hadliegh Wood Carved Bench**

Outside: H20.5 W52 D16



870-O

**Narcisse Cocktail Ottoman**

Outside: H19 W42 D30



856-O

**Gainsborough Bench**

Outside: H23 W49 D21



## BENCHES & ACCENT OTTOMANS



837-O

**Billingsly Bench with Hand Tufted Corners**

Outside: H19 W42 D42



836-O

**Billingsly Bench with Hand Tufted Top**

Outside: H18 W52 D28



698-O

**Baur Square Ottoman**

Outside: H19 W42 D42



699-O

**Baur Rectangle Ottoman**

Outside: H19 W30 D42.5

## BENCHES & ACCENT OTTOMANS



806-O

**Dundee Bunching Bench**

Outside: H21 W24 D18



716-O

**Monticello Bunching Ottoman**

Outside: H20 W24 D18



803-O

**Grimsby Bunching Bench**

Outside: H17 W22 D22



872-O

**Palazzo Bunching Bench**

Outside: H20 W20 D18



DINING CHAIRS  
& BARSTOOLS

## DINING CHAIRS & BARSTOOLS



4829H-10

**Charlie High Back Side Chair**

Outside: H37.5 W20 D24.5

Inside: H17 W20 D18.5

Seat: H20



4829L-10

**Charlie Low Back Side Chair**

Outside: H33 W19.5 D23

Inside: H11.5 W19.5 D18.5

Seat: H20



4828-10

**Charlie Armless Barstool**

Outside: H40 W20 D21.5

Inside: H8 W20 D17.5

Seat: H30



4828L-10

**Charlie Armless Counter Stool**

Outside: H32 W20 D21.5

Inside: H8 W20 D17.5

Seat: H24



## DINING CHAIRS & BARSTOOLS



775

### **Covington Side Dining Chair**

Outside: H41 W22 D28  
Inside: H22.5 W19.5 D19  
Seat: H29.5



776

### **Covington Arm Dining Chair**

Outside: H41 W23.5 D28  
Inside: H22.5 W19.5 D19.5  
Seat H19.5 Arm H20.5



750

### **Julie Arm Dining Chair**

Outside: H44 W25 D29.5  
Inside: H25 W21 D20.5  
Seat H20 Arm H25.5



139

### **Willem Dining Chair**

Outside: H37 W19 D24  
Inside: H16 W19 D19  
Seat: H21

## DINING CHAIRS & BARSTOOLS



766-CS

**Abbott Counter Stool**

Outside: H25 W17 D17



759-CS

**Montrose Counter Stool**

Outside: H24.5 W19 D19



773-CS

**Basalt Counter Stool**

Outside: H25 W19 D19

\*Complementary Ottoman **773-O**



## DINING CHAIRS & BARSTOOLS



719-CS

**Edam Counter Stool**

Outside: H36 W20-14 D19.5

Inside: H11 D17

Seat: H27



719-BS

**Edam Barstool**

Outside: H42 W20-14 D19.5

Inside: H11 D17

Seat: H33



771-CS

**Ava Swivel Counter Stool**

Outside: H39 W22 D24

Inside: H16 W17.5 D19.5

Seat: H25



771-BS

**Ava Swivel Barstool**

Outside: H45 W22 D24

Inside: H16 W17.5 D19.5

Seat: H31



## DINING CHAIRS & BARSTOOLS



793-CS

**Hague Swivel Counter Stool**

Outside: H40.5 W24.5 D26  
Inside: H18 W20-16 D18.5  
Seat: H25 Arm: H26



793-BS

**Hague Swivel Barstool**

Outside: H46.5 W24.5 D26  
Inside: H18 W20-16 D18.5  
Seat: H31 Arm: H32



508-10

**Lowell Armless Swivel Barstool**

Outside: H45 W22 D24.5  
Inside: H15 W22 D19.5  
Seat: H30

Also Available:

508L-10 Counter Height Armless Swivel Barstool



508

**Lowell Swivel Barstool**

Outside: H45 W23 D24.5  
Inside: H15 W20.5 D19.5  
Seat: H30 Arm: H35

Also Available:

508L Counter Height Swivel Barstool



## DINING & BARSTOOLS



1218

### **Baxter Barstool**

Outside: H42 W23.5 D23

Inside: H11 W17.5 D17

Seat: H30 Arm: H39



518

### **Jasper Swivel Barstool**

Outside: H43 W24 D27

Inside: H10 W20 D21

Seat: H30

Also Available:

518L Counter Height Barstool

518R Round Barstool (backless)

518RL Counter Height Round Barstool



## DINING & BARSTOOLS



508R

**Lowell Round Swivel Barstool**

Outside: H30 W22 D22

Also Available:

508RL Counter Height Round Swivel Barstool



538

**Cosmo Barstool**

Outside: H31 W19 D17



810

**Apothecary Wood Carved Counter Stool**

Outside: H25 W18 D11

Base: H25 W22.5 D15.5



809

**Apothecary Wood Carved Barstool**

Outside: H31 W18 D11

Base: H31 W25 D18

## DINING & BARSTOOLS



8128

**Hugh Barstool**

Outside: H46 W21 D27  
Inside: H15 W21 D19.5  
Seat: H30

Also Available:  
8128L Counterstool



8124

**Hugh Bench**

Outside: H35 W45 D25  
Inside: H15 W45 D19.5  
Seat: H20



8124H

**Hugh Bar Height Bench**

Outside: H46 W45 D27  
Inside: H15 W45 D19.5  
Seat: H31

Also Available:  
8124L Counter Height Bench







# EXECUTIVE CHAIRS



# EXECUTIVE CHAIRS



8213

**Kent Executive Chair**

Outside: H34.5 W26.5 D28.5

Inside: H15.5 W19.5 D19.5

Seat: H19 Arm: H23

Base: 51," Casters Std.



7173

**Hutton Executive Chair**

Outside: H41.5 W26 D32

Inside: H22.5 W19 D20

Seat: H19.5-22.5 Arm: H24-27

Base: #65



GT-186-S

**Elm Row Executive Swivel**

Outside: H35.5-37.5 W26.5 D30

Inside: H22 SW21 D18

Seat: H18.5-20.5 Arm: H24-26



186-CH

**Elm Row Guest Chair**

Outside: H38 W26.5 D28

Inside: H22 W21 D18

Seat: H18.5 Arm: H25

## EXECUTIVE CHAIRS



7353

**Lawton Executive Chair**

Outside: H33-36 W24 D28  
Inside: H18 W19 D19  
Seat: H18-21 Arm: H19-22  
Base: 85S-R,'O' Casters Std.



G-771-S

**Ava Executive Swivel**

Outside: H30.5-33.5 W25.5 D25.5  
Inside: H15.5 W19.5 D19  
Seat: H18-21



GT-730-S

**Waning Crescent Executive Chair**

Outside: H35.5 W26.5 D26.5  
Inside: H14 W22 D19  
Seat: H20



GT-126-S

**Blackstone Executive Swivel**

Outside: H41.5-43.5 W27 D31  
Inside: H21 W17.5 D19  
Seat: H21-23 Arm: H26-28

## EXECUTIVE CHAIRS



GT-117-S

**Brixton Executive Swivel**

Outside: H37-39.5 W28 D27.5

Inside: H18 W23.5 D18.5

Seat: H21.5-24 Arm: H25.5-28



GT-293-S

**Matrix Executive Swivel**

Outside: H38-40 W29 D28

Inside: H22 W19.5 D18

Seat: H19-21 Arm: H25.5-27.5



GT-113-S

**Shoreditch Executive Swivel**

Outside: H41-43 W26 D32

Inside: H25 W18.5 D18.5

Seat: H20.5-22.5 Arm: H26-28



GT-114-S

**Brick Court Executive Swivel**

Outside: H43-45 W30 D32

Inside: H27.5 W18 D19

Seat: H21-23 Arm: H28-30

## EXECUTIVE CHAIRS



9133

### **Asher High Back Tilt Swivel Chair**

Outside: H41-44 W26 D30

Inside: H25 W18 D19

Seat: H19-22 Arm: H25-28

Base: 10lg-d, 'N' Casters Std.

Also Available:

9133H Asher Extra Large High Back Tilt Swivel Chair



7133

### **Thornton High Back Executive Tilt Swivel Chair**

Outside: H43-46 W26 D30

Inside: H27 W20 D19

Seat: H20-23 Arm: H23-26

Base: 65l-6, 'O' Casters Std.



7072

### **Richmond Low Back Tilt Swivel Chair**

Outside: H39-42 W26 D29

Inside: H21 W20 D20

Seat: H20-23 Arm: H26-29

Base: 85LC-Q,'N' Casters Std.



GT-135-S

### **Fountain Court Executive Swivel**

Outside: H44.5-46.5 W25.5 D33

Inside: H24.5 W18.5 D19

Seat: H20.5-22.5 Arm: H25.5-27.5



# EXECUTIVE CHAIRS

BEST SELLER



GT-115-S

**Queen's Counsel Executive Swivel**

Outside: H44-46 W31 D31

Inside: H28 W20 D19

Seat: H19-21 Arm: H27-29



GT-143-S

**Doughty Street Executive Swivel**

Outside: H42.5-44.5 W30 D28

Inside: H24 W18 D19

Seat: H20.5-22.5 Arm: H27.5-29.5



613-25

**Cambridge High Back Tilt Swivel Chair**

Outside: H45-48 W31 D34

Inside: H27 W20 D20

Seat: H20-23 Arm: H26-29

Base: 55L-5, 'O' Casters Std.



663-15

**Chandler Executive Chair**

Outside: H47-50 W32 D36

Inside: H25 W23 D21

Seat: H22-25 Arm: H27-30

Base: 55L-5, 'O' caster std.

# CONTRACT FURNITURE

Leathercraft by OHD is one of the best manufacturers of exceptional quality made upholstered furniture in the USA.

At Leathercraft, our mission is to produce the most comfortable luxury seating in the marketplace using the healthiest and safest materials available, and to offer the best customer service in the industry. This is the standard we have achieved, and we are committed to keeping.

Our furniture is built to last a lifetime. We are dedicated to creating furniture with the highest quality care and materials. Ensuring strength and comfort for generations.

\*Contact our office for more information on furniture for contract production.



## EXECUTIVE CHAIRS



GT-199-S

**Westbourne Park Executive Swivel**

Outside: H44.5-46.5 W30 D36

Inside: H29 W19 D20

Seat: H19.5-21.5 Arm: H26.5-28.5



7193

**Phelps Executive Chair**

Outside: H45-48 W29 D34

Inside: H23 W18 D21

Seat: H21-24 Arm: H27-30



GT-298-S

**Essex Chambers**

Outside: H40.5-42.5 W29 D33

Inside: H21 W20 D20

Seat: H19-21 Arm: H20-22



GT-295-S

**Essex Chambers Tufted**

Outside: H40.5-42.5 W29 D33

Inside: H21 W20 D20

Seat: H19-21 Arm: H20-22

## EXECUTIVE CHAIRS



GT-108-S

**Langthorn Swivel Chair**

Outside: H39.5-41.5 SW24 D29

Inside: H24 W20 D19

Seat: H20-22 Arm: H27-29



GT-109-S

**Langthorn Tufted Back Swivel Chair**

Outside: H39.5-41.5 W24 D29

Inside: H24 W20 D19

Seat: H20-22 Arm: H27-29



GT-110-S

**Langthorn Tufted Swivel Chair**

Outside: H39.5-41.5 W24 D29

Inside: H24 W20 D19

Seat: H20-22 Arm: H27-29



G-174-S

**Goose Alley Armless Swivel Chair**

Outside: H34.5-36.5 W21 D25

Inside: H20 W21 D16

Seat: H18-20



## EXECUTIVE CHAIRS



108

**Langthorn Guest Chair**  
Outside: H41 W24 D29  
Inside: H24 W20 D19  
Seat: H20 Arm: H28



109

**Langthorn Tufted Back Guest Chair**  
Outside: H41 W24 D29  
Inside: H24 W20 D19  
Seat: H20 Arm: H28



110

**Langthorn Tufted Guest Chair**  
Outside: H41 W24 D29 SD19  
Inside: H24 W20 D19  
Seat: H20 Arm: H28



G-175-S

**Goose Alley Armless Tufted Swivel Chair**  
Outside: H34.5-36.5 W21 D25 SD16  
Inside: H20 W21 D16  
Seat: H18-20

## EXECUTIVE CHAIRS



GT-796-S

### **Bozeman Upper House Swivel Chair**

Outside: H38-40 W26 D30  
Inside: H21 W22 D21  
Seat: H20.5-22.5 Arm: H26-28



763-18HR

### **Judge's Tilt Swivel Chair**

Outside: H45-48 W25 D32  
Inside: H28 W20 D20  
Seat: H19-22 Arm: H25-28  
Base: 55L-5, 'O' Casters Std.

Also Available:  
763-28HR Tilt Swivel Chair



793-18

### **Sullivan Tilt Swivel Chair**

Outside: H45-48 W26 D32  
Inside: H26 W20 D20  
Seat: H19-22 Arm: H26-29  
Base: 55L-5, 'O' Casters Std



BEST SELLER

## EXECUTIVE CHAIRS



GT-116-S

**Keating Executive Swivel**

Outside: H42-44 W30 D30

Inside: H25 W17 D19

Seat: H22-24 Arm: H28-30



GT-144-S

**Keating Tufted Executive Swivel**

Outside: H42-44 W30 D30

Inside: H25 W17 D19

Seat: H22-24 Arm: H28-30



623-38

**Curtis Tilt Swivel Chair**

Outside: H43-46 W31 D30

Inside: H23 W20 D20

Seat: H19-22 Arm: H26-29

Base: 55L-5, 'O' Casters Std.



623-18

**Curtis Tilt Swivel Chair**

Outside: H43-46 W31 D30

Inside: H23 W20 D20

Seat: H19-22 Arm: H26-29

Base: 55L-5, 'O' Casters Std

## EXECUTIVE CHAIRS



131-38

### Henry Wing Chair

Outside: H43 W31 D30

Inside: H24 W20 D19

Seat: H19 Arm: H26

Also Available:

131-17 Wing Chair (non-tufted)



GT-766-S

### Rue Pouchet

Outside: H41.5-43.5 W27 D33

Inside: H21 W20 D20

Seat: H21.5-23.5 Arm: H26.5-28.5



## HOME & OFFICE

Our collection of home office products will expand the way you think about creating work areas within your home. We encourage combining your home office area within a family room, living room or even a bedroom as it can be functional, efficient and very attractive. Our styles featured range from traditional to contemporary and the quality level will easily integrate with the rest of your home.





# MANHATTAN SERIES

## MANHATTAN SERIES



920-02

**Manhattan Lounge Chair**

Outside: H36 W37 D37

Inside: H16 W24 D22

Seat: H20 Arm: H24

**920-03 Manhattan Ottoman**

Outside: H14 W27 D21



920-00

**Manhattan Sofa**

Outside: H36 W87 D37

Inside: H16 W74 D22

Seat: H20 Arm: H24



921-00

**Manhattan Sofa (with welt)**

Outside: H36 W87 D37

Inside: H16 W74 D22

Seat: H20 Arm: H24



920-00/40

**Manhattan Sofa**

Outside: H36 W87 D39

Inside: H16 W74 D24

Seat: H20 Arm: H24

## MANHATTAN SERIES



40-0-114

**Manhattan Select Sofa**  
Outside: H36 W86 D40  
Inside: H16 W74 D24  
Seat: H20 Arm: H24



40-0-434

**Manhattan Select Sofa**  
Outside: H36 W86 D40  
Inside: H16 W73.5 D24  
Seat: H20 Arm: H24



40-0-313

**Manhattan Select Sofa**  
Outside: H36 W88 D40  
Inside: H16 W74 D24  
Seat: H20 Arm: H24



40-0-533

**Manhattan Select Sofa**  
Outside: H36 W88 D40  
Inside: H16 W73.5 D24  
Seat: H20 Arm: H24



## MANHATTAN SERIES

*Also Available:*

920-02 Chair

920-03 Ottoman

921-02 Lounge Chair

920-03L Large Ottoman

920-04 Bumper Ottoman

920-05 Loveseat

920-00 Sofa

920-00/1 Single Seat Sofa with buttons

920-00-68S Sleeper Sofa

920-00/1-68S Single Seat Sleeper Sofa

920-00 Sectional Series





# MANHATTAN SECTIONAL SERIES

## 920-00 MANHATTAN MODULAR SERIES

Double Needle Stitching



920-05LAW

920-09

920-05RAW



< Back: loose pillow back/zipper with double needle stitching.

---

## 921-00 MANHATTAN MODULAR SERIES

Welted



921-00-1L

921-00LC-10

921-04



< Back: loose pillow back/zipper with welt

# MANHATTAN SECTIONAL SERIES

\*All pieces are available in both series 920-00 & 921-00



**920-02-10**  
Armless Chair  
H36 W25 D37  
Inside: H16 W25 D22  
Seat H:20

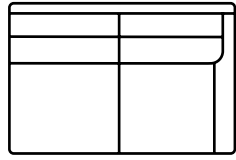

**920-05-1R**  
Right Arm Loveseat  
H36 W55 D37  
Inside: H16 W49 D22  
Seat H:20 Arm H:24

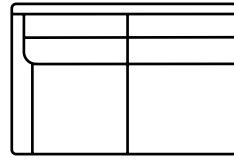

**920-05-1L**  
Left Arm Loveseat  
H36 W55 D37  
Inside: H16 W49 D22  
Seat H:20 Arm H:24

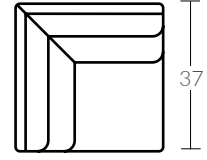

**920-02-35**  
Corner Chair  
H36 W37 D37  
Inside: H16 W22 D22  
Seat H:20

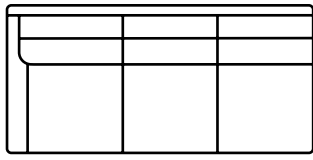

**920-00-1L**  
Left Arm Sofa  
H36 W79 D37  
Inside: H16 W74 D22  
Seat H:20 ARM H:24  
*\*Also Available with Limited Styles:  
920-68S-1L Left Arm Sleeper Sofa*

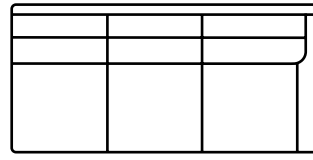

**920-00-1R**  
Right Arm Sofa  
H36 W79 D37  
Inside: H16 W74 D22  
Seat H:20 Arm H:24  
*\*Also Available with Limited Styles:  
920-68S-1R Right Arm Sleeper Sofa*

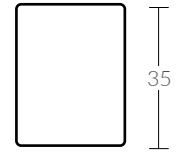

**920-04**  
Bumper Ottoman  
H16 W35 D26

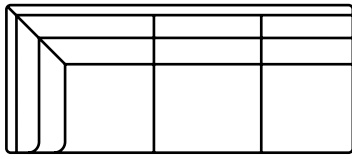

**920-00-LC-10**  
Left Corner Armless Sofa  
H36 W84 D37  
Inside: H16 W72 D22  
Seat H:20

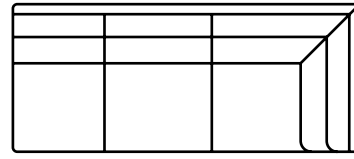

**920-00-RC-10**  
Right Corner Armless Sofa  
H36 W84 D37  
Inside: H16 W72 D22  
Seat H:20

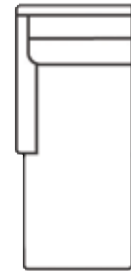

**920-08-16**  
Left Arm Chaise  
H36 W32 D62  
Inside: H14 W26 D49  
Seat H:21 Arm H:23

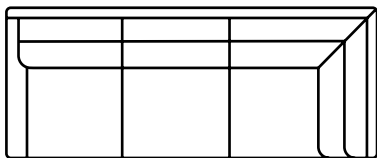

**920-00L**  
Left Arm Corner Sofa  
H36 W90 D37  
Inside: H16 W74 D22  
Seat H:20 Arm H:24

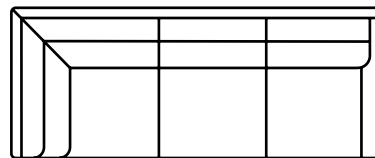

**920-00R**  
Right Arm Corner Sofa  
H36 W90 D37  
Inside: H16 W74 D22  
Seat H:20 Arm H:24



**920-08-15**  
Right Arm Chaise  
H36 W32 D62  
Inside: H14 W26 D49  
Seat H:21 Arm H:23

# MANHATTAN SELECT SERIES

**SELECT YOUR STYLE:** '20' indicates standard 22" inside seat depth; '40' indicates 24" inside seat depth

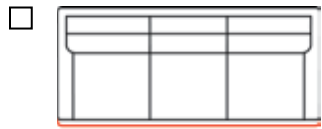

20-0 or 40-0  
Sofa

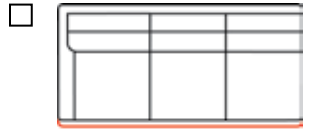

20-0-1L or 40-0-1L  
Left Arm Sofa

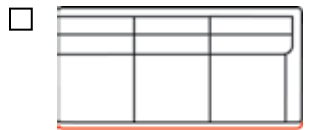

20-0-1R or 40-0-1R  
Right Arm Sofa



20-0L or 40-0L  
Left Arm Corner Sofa

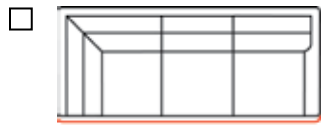

20-0R or 40-0R  
Right Arm Corner Sofa

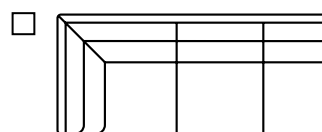

20-0-LC-10 OR 40-0-LC-10  
Left Corner Armless Sofa

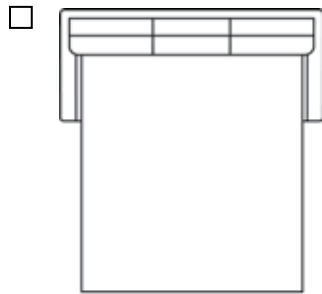

20-68S/  
Sleeper Sofa  
*\*Only Available in Standard 20" Depth*

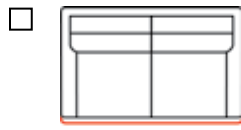

20-5 or 40-5  
Loveseat

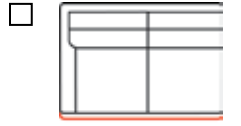

20-5-1L or 40-5-1L  
Left Arm Loveseat



20-5-1R or 40-5-1R  
Right Arm Loveseat

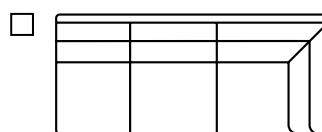

20-0-RC-10 OR 40-0-RC-10  
Right Corner Armless Sofa

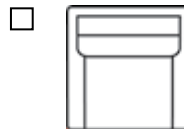

20-2 or 40-2  
Chair

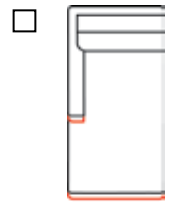

20-8-16 or 40-8-16  
Left Arm Chaise

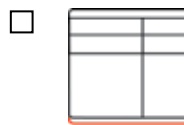

20-5-50 or 40-5-50  
Armless Loveseat

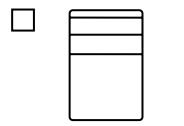

20-02-10  
Armless Chair

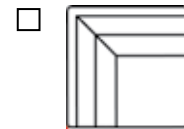

20-2-35 or 40-2-35  
Corner Chair

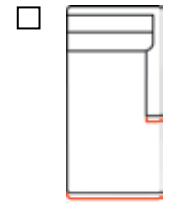

20-8-15 or 40-8-15  
Right Arm Chaise



20-3  
Ottoman

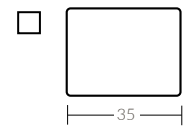

20-04  
Bumper Ottoman

**\*Example Style Number:**

Sofa with a 24" inside seat depth, #2 cap arm, #1 square corner back w/ ears and #3 block feet would be: 40-0-213 Sofa

Matching Chair & Ottoman:

40-2-213 Chair  
20-3-3 Ottoman

**SELECT YOUR ARM:**



Track Arm



Cap Arm\*



Padded Track Arm\*

**SELECT YOUR BACK:**



Square Corners With Ears



Square Corners Without Ears

**SELECT YOUR FOOT/LEG:**



Tapered Foot



Block Foot



Sled Leg

**OPTIONAL NAILS:**

- Yes
- No

*\*Upcharge Applies*

< #2 & #3 Arms shown with Optional Nails

\*See Price Book for Standard Features



WOOD TRIM & NAILS



# WOOD FINISHES



No. 2  
Dark Walnut

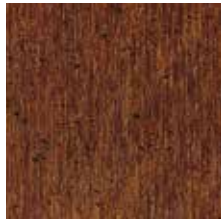

No. 3  
Fruitwood



No. 5  
Red Cherry



No. 6  
Brown Cherry

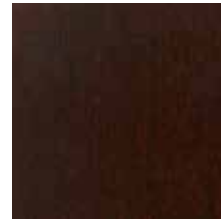

No. 7  
Dark Roast



No. 10  
Ebony



No. 13  
Colorado Brown



No. 20  
Pickled Pine



No. 21  
Cognac



No. 22  
Honey



No. 23  
St. Croix



No. 27  
Provence



No. 28  
Aged Ebony



No. 34  
Urban White



No. 38  
Driftwood



No. 39  
Cape Cod



No. 43  
Linen



No. 45  
Soft Bronze



No. 48  
Limestone

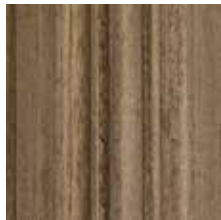

No. 49  
Pecan

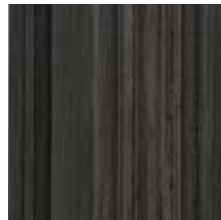

No. 50  
Slate



No. 52  
Native Satin

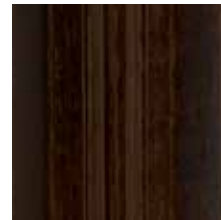

No. 53  
Coffee

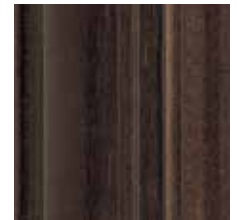

No. 54  
Nutmeg

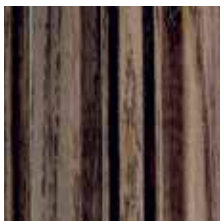

No. 55  
Streak

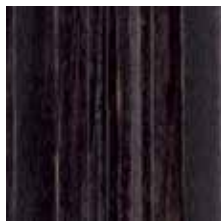

No. 56  
Heritage



No. 58  
Pure Honey

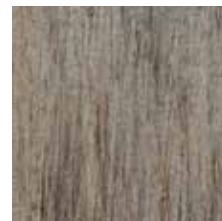

Aged White  
Wash



Auburn

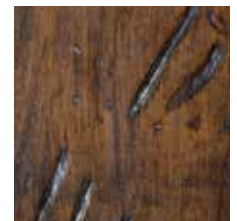

Countryside

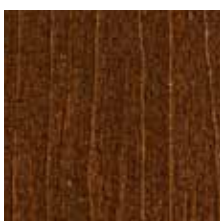

Distressed  
Umber

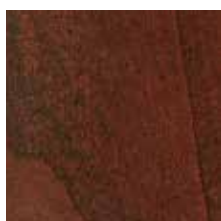

Mahogany

\*Colors shown may vary from actual finishes due to printing process, photography, and the grain of wood. All decorative finishes are hand done and will have unique character. Texture and variations found in wood will cause variation in finishes. No two pieces will be exactly alike.

\*See Price Book for Standard Features

## WOOD FINISHES

- \*Exposed wood surfaces are carefully shaped, carved and integrated into each frame.
- \*Each is hand sanded, stained and hand rubbed to accentuate the natural grain.
- \*Three successive coats of lacquer seal the surface and add a lustrous sheen.
- \*Our exacting 19-step finishing process results in a remarkably durable surface.
- \*No distressing is available upon request.



## POWDERCOAT FINISHING

A large variety of finishes ranging from saturated solid colors to bronze and other precious metal options are available through the use of powder coating on Leathercraft's metal framed items. Please refer to the Cardinal Powder Coat Finish brochure or it can be downloaded at [www.cardinalpaint.com](http://www.cardinalpaint.com). Contact customer service for a complete list of appropriate products.





# NAIL TRIM



Antique  
Bronze



Antique  
Gold



Antique  
Nickle



Black  
Chrome



Chrome



French  
Natural

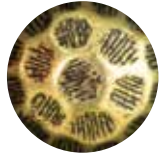

Hammered  
Gold



Light  
Gold



Natural



Onyx  
Gold



Pearl  
Grey



Pewter

\*Nails are to scale

\*Asterisk denotes upcharge

\*When using anything other than standard size and placement there is an upcharge



Standard



\*Medium



\*Large





## FEATURES & BENEFITS



# FEATURES & BENEFITS

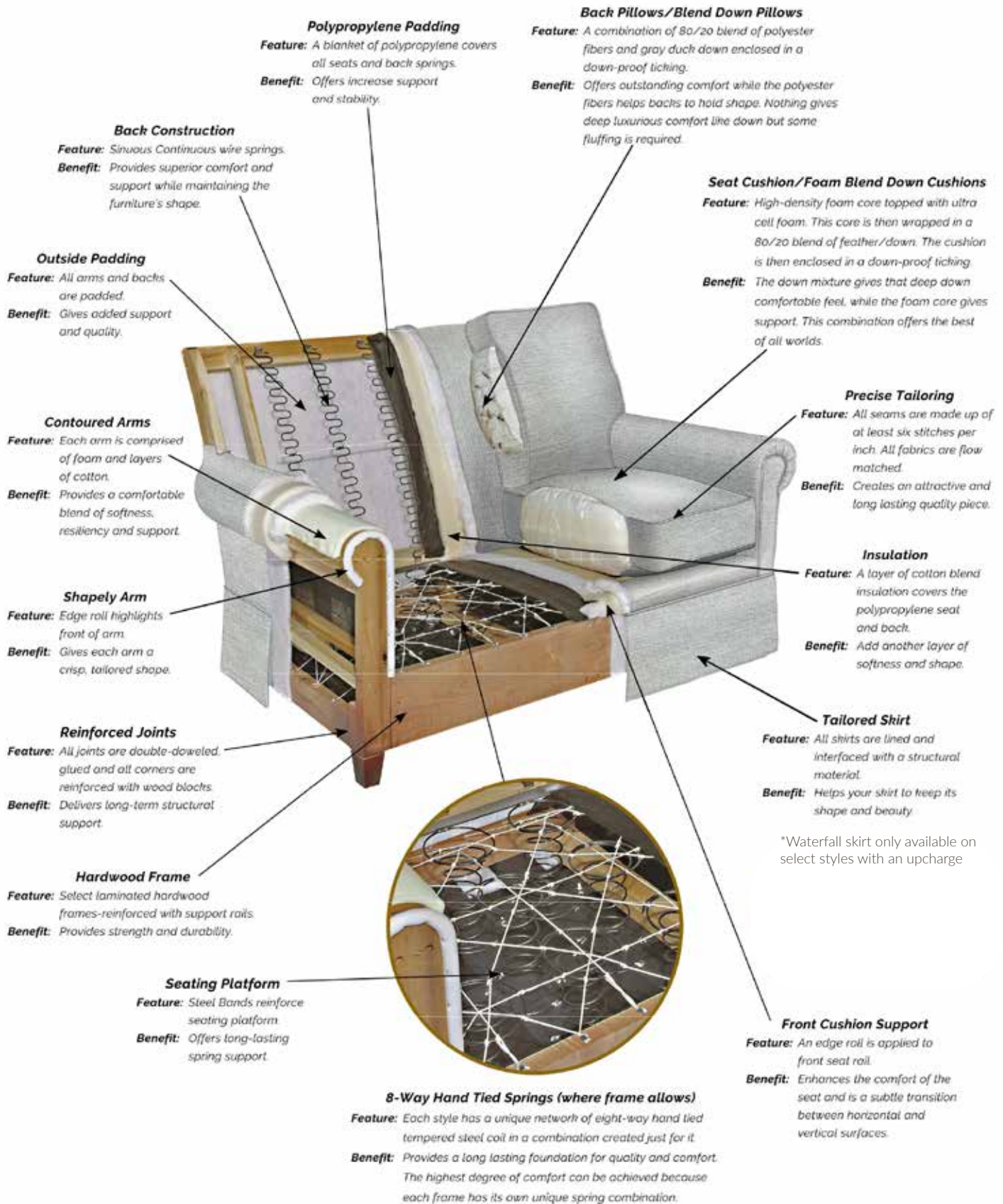

\*Variation of 1-2" on all frame dimensions is standard within the industry

# SEAT CUSHIONS & PILLOWS

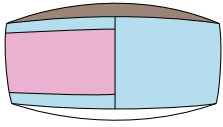

**Foam Blend Down** | This cushion is comprised of a combination of two foams in the core. The inner core is high-density foam to insure support and a layer of soft plush foam is added to give an initial soft comfort sit. This combination foam core is then enclosed in a 80%-20% blend of fibers and feather/down. This poly/feather/down mixture is encased in down-proof ticking, which is channeled to keep fibers smooth and separated. Foam Blend Down seats have a casual, relaxed look. **Some packing of the fiber should be expected and not considered a defect. Approximately 10% of packing is expected. Occasional fluffing should be expected.** Please refer to the limited warranty page for more information on the warranty for cushions. | page 142

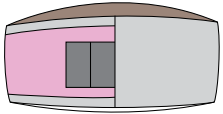

**Lounge Spring Down** | This cushion is a marshall spring core unit wrapped in polyurethane foam. This core is then enclosed in a 50/50 blend of polyester fibers and fiber/down. This fiber/down mixture is encased in a down-proof ticking, which is channeled to keep fibers smooth and separated. Lounge Spring Down seats have a casual, relaxed look. **Some packing of the fiber should be expected and not considered a defect. Occasional fluffing should be expected.** This is a one-sided, non-flippable cushion that is offered on select styles only.

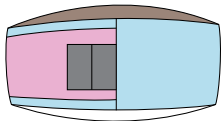

**Spring Blend Down** | This cushion has a marshall spring core unit wrapped in polyurethane foam. this core is then enclosed in a 80%-20% blend of polyester fibers and fiber/down. This poly/feather/down mixture is encased in down-proof ticking, which is channeled to keep fibers smooth and separated. Spring Blend Down seats have a casual, relaxed look. **Some packing of the fiber should be expected and not considered a defect. Occasional fluffing should be expected.** Please refer to the limited warranty page for more information on the warranty for cushions. | page 142

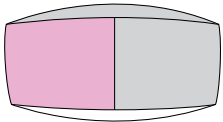

**Classic Comfort** | This cushion is a high-density foam core wrapped in Dacron fiber on top, bottom, and sides. This core is then encased in a non-woven cover filled with polyester blend down fiber. This cushion is allergy friendly for those who are allergic to feather/down cushions.

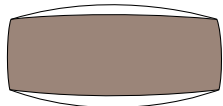
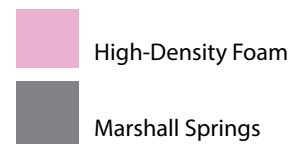
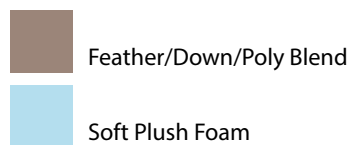
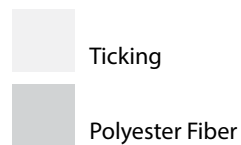

**Blend Down Back Pillow** | The ultimate fill for back cushions or throw pillows. These backs are filled with a combination polyester fibers and grey duck down/feathers enclosed in a down-proof ticking. **Some packing of the fiber should be expected and not considered a defect. Occasional fluffing should be expected.**

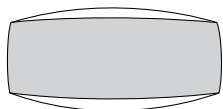

**Classic Comfort Back Pillow** | The fiber in our backs is conjugated polyester. This fiber is naturally non-absorbent and resists matting, clumping, and mildew. It is odorless, lint free and non-allergenic. All fibers are blown into channel-sewn back ticking. These channels help maintain the proper proportions of back filling. **Some packing of the fiber should be expected and not considered a defect. Occasional fluffing should be expected.**



Our cushions and back pillows are proudly crafted in America. We recognize that every frame has its own ergonomics. To achieve ultimate comfort, we offer only the most premium foams, fibers, and feathers.

# LEATHER CARE

**Leather Types** | There are 3 available leather types - Aniline, Nubuck, and Protected - each merit specialized handling based on their individual qualities. Natural color variations expected in Aniline leathers inspire the assembly of hides to create a natural color match that flows from light to dark. No two leather tones are the same. The unique beauty of the natural medium emerges as our craftsmen leverage the harmony of the color to fan 4-5 hides across a sofa and create a one-of-a-kind piece.

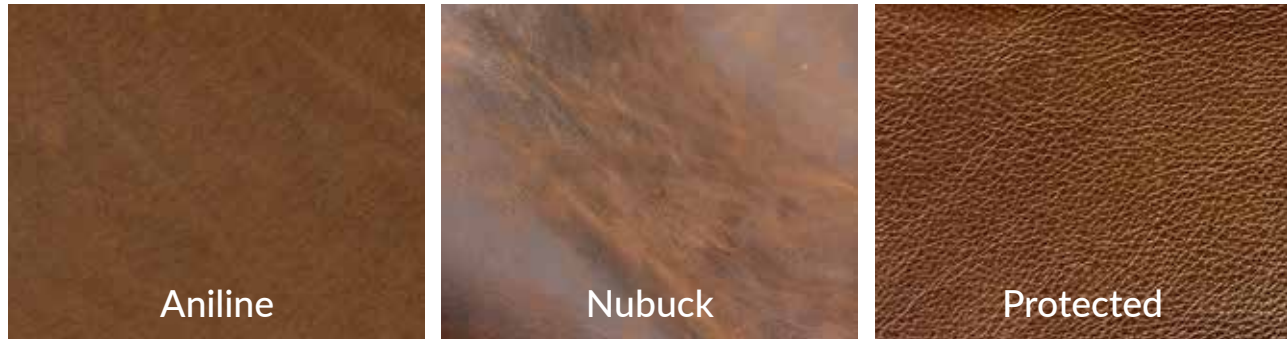

**Beauty Marks** | Natural “beauty marks” left in the hide by fat wrinkles, ticks, and healed scars lend character, depth and authenticity to the leather’s heritage. These unique markings give every furniture piece its own distinct personality. Our cutters’ experienced eyes envision a pattern layout that preserves the quality and value inherent in the leather’s natural beauty.



**Aniline** | Also called “Pure Aniline” or “Naked Aniline”. Color is added to these hides much like a stain added to wood. This process allows the natural markings of the leather to show. Pure Aniline is the most honest expression of leather you can buy. All of nature’s beauty marks will be evident, in their authentic, unvarnished glory. Pure Aniline leathers get better with age, absorbing minor scratches and nicks gracefully. Over time it will be as though your own life’s history melds with the original owner’s.

Aged Aniline leathers are Pure Anilines that have had a finish added to them. A wax, oil or transparent stain is added to create additional ecstatic appeal. These wax and oil finishes will change in color when applied to the frame, helping to add highlights of colors and interest to the detailing of the frame. This helps give each piece its own distinctive look. Most wax and oil finishes will show marks and highlight wear spots. This is intentional and will give each piece a worn look over time. (Much like buying a pair of faded jeans.) Though Aged Aniline is slightly less vulnerable to stains and spills than Pure Aniline, neither is recommended for settings where “accidents” are likely a frequent occurrence. Signs of natural beauty markings include healed scars, cuts and insect bites, stretch marks, fat wrinkles, tight pores, backbone impressions and neck wrinkles. Color variations are expected throughout the hide.

**Caring for Pure & Aged Aniline** | Direct sunlight will rob these leathers of their richness. Attend to spills immediately with a clean white cloth, blotting, never pressing on the spill. Never use heat or soaps on these leathers. Should a spill penetrate the leather, gently massage the area with a clean white cloth lightly dampened with distilled water. Contact a professional leather cleaner for serious stains.



# LEATHER CARE

**Nubuck** | After Aniline dyeing, these top grain leathers move on to a finishing process of gentle buffing and polishing that removes the top cell layer. The effect is a whisper-soft nap that adds a tactile pleasure to compliment the visual beauty. Buffing only slightly obscures the hide's color variations and natural markings. A wax or topical coating may be applied during finishing for additional surface interest. Signs of natural beauty markings include healed scars, cuts and insect bites, stretch marks, fat wrinkles, tight pores, backbone impressions and neck wrinkles. Color variations are expected throughout the hide.

Because structures in the skin vary, these hides absorb dye unevenly, creating significant color variations. Their surfaces are then machined with fine brushes to create the famous Nubuck "hand". This gives the leather a depth of color and shading not found in any other type.

**Caring for Nubuck Aniline** | Direct sunlight will rob these leathers of their richness. Attend to spills immediately with a clean white cloth, blotting, never pressing on the spill. Never use heat or soaps on these leathers. Should a spill penetrate the leather, allow the spill to dry. Use a suede brush, or vacuum with drapery attachment, and brush the nap. If additional cleaning is required, gently massage the area with a clean white cloth lightly dampened with distilled water. Allow the area to dry and, again, use a suede brush or vacuum with drapery attachment.

**Protected** | Protected leathers are the perfect choice for people who expect the most out of life and demand high performance from their leather. They are dyed in a process similar to painting: which does hide some of the natural characteristics of leather, such as scars ect. However, it insures a consistent color range throughout the hide. Then a clear top coat that repels spills and stains is added. This gives it a high resistance to fading, liquids, and stains.

Protected Leathers are also sometimes called Semi-Anilines. This refers to leathers that have gotten their color through a process similar to stain versus paint. It still allows the leathers natural characteristics to show up. Just like when wood on a home is stained you can see the knots and natural characteristics coming through the stain. Then a clear coat that repels spills and stains is added. This gives it a high resistance to fading, liquids and stains. Because of the top coat, the leather will not have the same soft subtle hand as found in Pure Aniline.

**Caring for Protected Leathers** | Although no material is totally impervious to the fading caused by sunlight, Protected leathers hold up best. Rearranging the furniture on occasion will extend the life of its rich color even further. As for spills, most should blot up without a trace. Routine cleaning with a clean white cloth dampened with distilled water will eliminate the buildup of dirt and oils that can de-color the leather over time and break down the protective coating.

\*For More information about cleaning of your leather, you may want to contact **Unifers North America at (888) 825-6551**. This is a company that specializes in the care and cleaning of leather. They have over 200 products for leather and may be able to help you with special cleaning needs or information on how to best protect your leather. They are much like a local dry cleaning company that would handle your silks and linens. When Unifers North America products are applied correctly, Leathercraft by OHD will not void their construction warranty covering frame, seating and spring up. Unifers North America is separate company marketing their products across the United States and is in no way affiliated with Leathercraft by OHD.





# WARRANTY

## Frame | Limited Lifetime Warranty

As long as you, the original purchaser at retail, own the upholstery furniture, the frame is warranted by Leathercraft Furniture by Our House Designs LLC., to you against defect in material and workmanship (excluding natural defect in wood) for the LIFETIME of the upholstered furniture. The upholstered piece must remain upholstered in the original leather or fabric and be used under normal wear and conditions.

## Spring | Limited Lifetime Warranty

As long as you, the original purchaser at retail, own the upholstery furniture, the spring system is warranted by Leathercraft Furniture by Our House Designs LLC., to you against defect in materials and workmanship for the LIFETIME of the upholstered furniture. The upholstered piece must remain upholstered in the original leather or fabric and be used under normal wear and conditions.

## Cushion Cores | 2 Year Warranty

LC by OHD warrants cushion cores against loss of resiliency for two (2) years when put to ordinary residential use. During the next three-year period (that is, the third, fourth and fifth year following your purchase) you may purchase a replacement cushion and the purchase price will be prorated based on the number of years remaining in an expected life of the product of five (5) years. \*Please note that the loss of resiliency should not be confused with the slight and expected softening and flattening of the polyester fiber, feather and down mixture, and foam components that occur as a result of normal use and aging. Such flattening and softening is not a material or manufacturing defect, and is not covered by this Warranty.

## Executive Swivel Chair Mechanisms | 5 Year Warranty

All executive swivel chair mechanisms and casters are warranted for 5 years from the date of purchase against defective materials and workmanship under normal wear and conditions.

## Casters | 90 Day Warranty

There is a 90 day warranty on the casters only. Our House Designs LLC., will not be liable for any damage caused to flooring. We ask that mats be placed under executive chairs, especially on hardwood floors.

## Leather & Fabric

Manufacturers of upholstery leathers and fabrics do not warrant their products for wearability or colorfastness. While Leathercraft Furniture by Our House Designs LLC. makes every effort to select products that are durable and colorfast, we are unable to honor adjustments, claims or credits for failure of these materials' properties. For more information on leather and care of leather refer to the leather care information page.

## Recliner & Vari-Tilt

Battery | 1 Year Warranty

Metal Frame & Hardware | 2 Year Warranty

Electronic Motor & Buttons | 2 Year Warranty

## Terms of Limited Warranty

This warranty does not apply to any conditions or defects resulting from normal wear and tear, negligence, abuse, fire, water, accidents, contact with rough or sharp objects, damage due to chemical treatment or improper cleaning, natural fading due to sun exposure, or shipping damage. The warranty is void if original leather or fabric is replaced.

This warranty applies to the original purchaser. The product must be in its original cover and cannot have been reupholstered.

If a defect is found. Leathercraft Furniture by Our House Designs LLC will repair or replace the defective item. After 1 year from date of purchase, this warranty ceases to cover costs of packaging and shipping to and from the factory. All claims made under this warranty must be made during the time periods indicated. For service, see your local Leathercraft Furniture by Our House Designs dealer.



## MECHANISM INFORMATION

# SWIVEL MECHANISMS

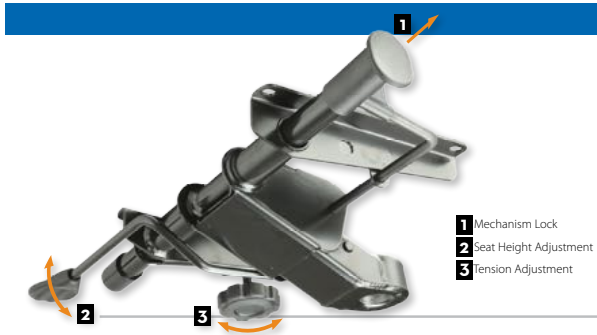

1. Pull knob out, in order to tilt chair back.
2. Before sitting, pull up to raise to highest position. Sit in the chair and touch lever to lower to height desired.
3. Turn to adjust tension: Clockwise to tighten; Counter Clockwise to loosen.



1. Pull out handle to release mechanism lock.
2. Before sitting, pull up to raise to highest position. Sit in the chair and touch lever to lower to height desired.
3. Turn to adjust tension: Clockwise to tighten; Counter Clockwise to loosen.

This unique gas knee tilt mechanism allows the forward positioning of the fulcrum (tilting axis) permitting the chair to tilt back from the front edge. This results in minimum vertical knee movement, eliminates upward thigh pressure and improves access to lower desk areas.

This mechanism features a bottom knob for tension adjust and dual-function, combination lever for its single position tilt lock and chair height adjustment.

## EXECUTIVE SWIVEL CHAIR MECHANISMS 2 YEAR WARRANTY

### Gas Knee Tilt Mechanism

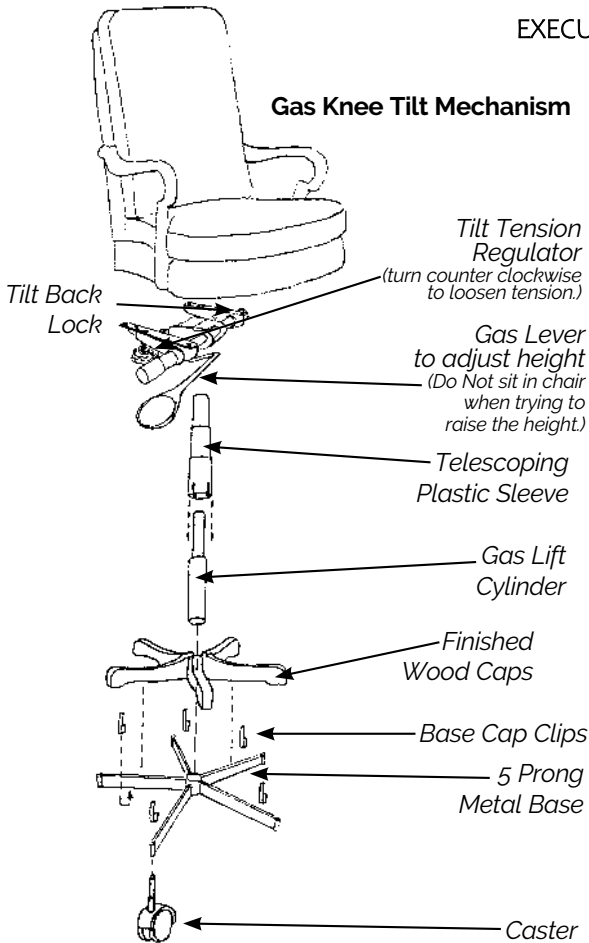

All executive swivel chair mechanisms are warranted for five years from the date of purchase against defective materials and workmanship under normal wear and conditions.



Optional Chrome Base and Chrome casters only available on Gas Knee Tilt Mechanism.

### Gas Mechanism

*Tilt Tension Regulator  
(turn counter clockwise to loosen tension.)*

*Mechanism Lock  
Seat Height Adjustment  
(Do Not sit in chair when trying to raise the height.)*

*Telescoping Plastic Sleeve*

*Gas Lift Cylinder*

*Finished Wood Caps*

*Base Cap Clips*

*5 Prong Metal Base*

*Caster*

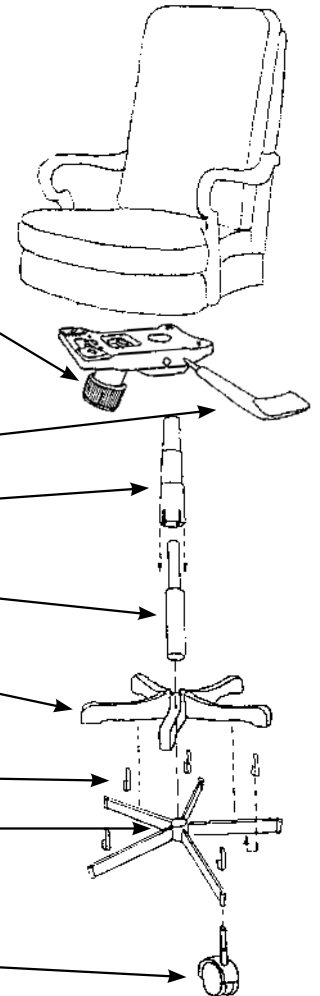

# CASTERS

\*90 Day Warranty on the Casters Only

Leathercraft by OHD will not be liable for any damages caused to flooring. We ask that mats be placed under executive chairs, especially on hard wood floors.

Please see the Price Book for standard base & caster options.



**Pacer Windsor Antique**



**Pacer Satin Chrome**



**Pacer Flat Black**



**Barron Hooded Ball**



**Caster O**



**Caster J**



**Rubber Wheel**





# RECHARGABLE BATTERY PACK FOR RECLINER

## FEATURES

- Provides power for up to 275 uses on a single charge dependent on configuration
- Easy to use LED charging indicator
- 5 hour charging time with integrated switching power supply
- System Requirements: 100Vac-240Vac, 50/60Hz
- Simple installation
- Designed and engineered in the USA
- United States based parts and technical support
- UL Listed
- 1 year warranty

## OPERATING INSTRUCTIONS

1. Be sure the battery is fully charged before use. To confirm this, press the Test button on the side of the unit. If the indicator light is green then the battery is ready for use. If the indicator light is red, plug it into an outlet to charge.
2. To install, connect the cord with the female connector to the male 2-pin plug hard wired to the recline motor. Be sure to position the battery pack in a location where the cord will not be damaged in the recline mechanism.
3. Press the test button on the side of the battery pack to check the status of the battery while in use. If the battery has enough power to properly operate the furniture the test button will activate a GREEN LED. When the battery drops to 20% capacity, the test button will activate a RED LED. When this occurs, plug the battery pack into a standard wall outlet to recharge.
4. During the charging process a LED light will constantly indicate the current status of the battery pack. A RED LED indicates the charging process is not complete. A GREEN LED indicates the battery is fully charged.

\*You have the option of using the battery while it is charging but this will require a much longer charging time before the battery is fully charged.

\*\*Do not completely drain the battery as this may reduce the life of the battery.

\*\*\*Once the battery is fully charged, unplug it from the wall outlet. Leaving the battery plugged into a wall outlet while fully charged will cause the battery to drain more quickly during use.

### Notes:

1. Do not dispose of electrical appliance as unsorted municipal waste, use proper collection facilities.
2. Contact your local government for information regarding the collection system available.
3. Use only a power supply cord, Type SPT-1, 22awg, two conductors, rated minimum 105°C, 300V, VW-1. One end terminates in an attachment AC plug of 15A, 125V (NEMA 1-15P) or 15A, 250V (NEMA 2-15P), the other end terminates in a molded-on connector which mates with the Power appliance inlet. Minimum 2.3m in length.

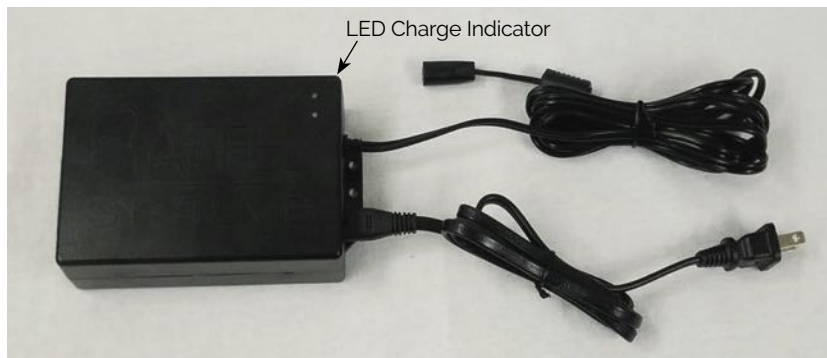

## TROUBLESHOOTING GUIDE

Problem: No Power Output from Battery Pack	Battery not Holding a Charge	LED Indicator Light Does Not Light Up When Plugged into Wall Outlet
Check the connection between the battery pack and the recline motor and check Battery status by pressing the Test button on side of unit.	The number of recline cycles the battery can execute depends on the size of the occupant and the number of accessories connected to the system such as LED lighting or USB chargers.	Confirm the AC cord is properly connected to the wall outlet and battery pack.
NO LED On: plug the battery pack into an outlet to-recharge. Wait 30 second and the RED LED will illuminate indicating it is charging.	Allow 5 hours to fully charge the battery pack. It may be beneficial to disconnect the battery pack from the furniture during the charging process.	Confirm outlet used for charging is working properly.
RED LED: this indicates the battery needs to be charged.	A fully charged battery pack should provide over 200 uses, dependent on load and accessories. The battery pack will discharge when idle.	Verify circuit breakers in the house are not tripped.
GREEN LED: indicates battery is fully charged and ready for use.	If the battery pack does not hold a charge as indicated then contact customer service at (888)987-1011 or customerservice@raffel.com.	If the battery pack does not recharge as indicated then contact customer service at (888)987-1011 or customerservice@raffel.com.

## WARNINGS

1. Keep away from flammable material and heat sources.
2. For indoor use only.
3. Dry location only.
4. Do not short circuit the battery, over charge or over discharge.
5. Do not allow the battery pack to become crushed.
6. Do not drop the battery into water.
7. Do not reverse the polarity.
8. Do not disassemble or repair the battery.
9. Do not install near metallic parts that could cause a short circuit.
10. Do not deform the battery housing.
11. Do not touch a leaky battery.
12. Do not use this battery with other devices it is not intended for.
13. Keep out of the reach of children.

## ONE YEAR LIMITED WARRANTY

# RECLINER MECHANISMS

## MOTORIZED OPTION

Recliner Switch - Standard: Black  
Battery option  
Metal seat frame  
Metal chassis for superior frame strength

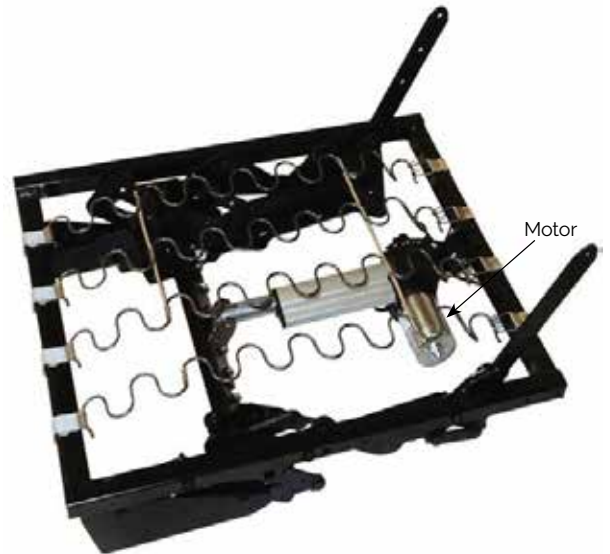

## WARRANTY

1 year from date stamped on battery  
2 years from date stamped on hardware  
2 years from date stamped on electronic/motor

## MANUAL PUSH-ON-ARM OPTION

Made in the USA  
Wear tested to 35k cycles  
Easy opening  
Excellent full recline balance  
Good extension  
Heavy gauge steel  
Solid shoulder rivets  
Long lasting bushings and washers made from delrin

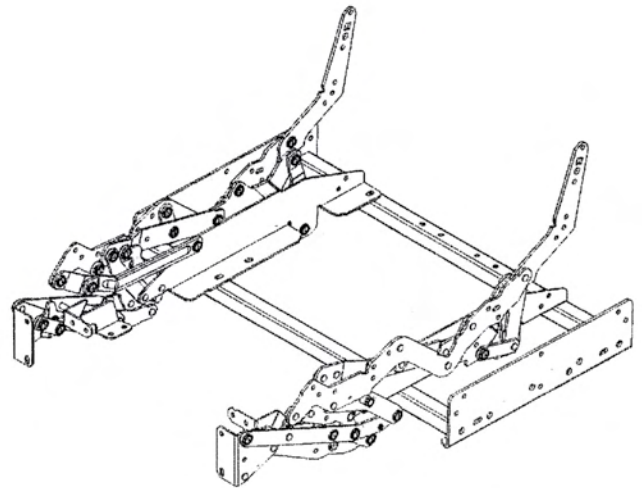

## FEATURES

Includes 8 foot cord  
LED Indicator signaling proper operation  
Quick disconnect for easy removal  
Wall mount style keeps power supply off the floor  
Locking connector to ensure proper connection



## ENDURING CRAFTSMANSHIP



Leathercraft by OHD furniture is built to last a lifetime. We are committed to creating furniture with the highest quality care and materials ensuring strength and comfort for generations.

All of our frames are made from solid hardwoods, reinforced with support rails, dowels, and screws. Sinuous wire springs are used in the backs of our pieces to provide superior support while maintaining the furniture's shape. Each sprung-up frame has a unique network of eight-way hand-tied tempered steel coils, providing a long-lasting foundation with the highest degree of comfort.

It's inspiring to watch our team members work their unique craft and bring life to each piece. Many of our furniture makers are 2nd and 3rd generation legacies, still employing the highest standard of time-honored furniture making traditions.





# INDEX



# NUMERICAL INDEX

40-0-114 Manhattan Sofa.....	128	317 Austin Chair.....	21	526 Braidwood Chair, Ott.....	29
40-0-313 Manhattan Sofa.....	128	337 Lombard St Bankers Chair.....	12	526-79 Braidwood Sofa.....	66
40-0-434 Manhattan Sofa.....	128	337-C Lombard St Bankers Caster Chair.....	12	526 Braidwood Sectional Series.....	83
40-0-533 Manhattan Sofa.....	128	390 Bishopsgate Chair.....	31	527 Stanhope Chair.....	34
042 Blayne Ease Back Chair, Ott.....	54	390-83 Bishopsgate Sofa.....	68	527-86 Stanhope Sofa.....	73
052 Bradley Ease Back Chair.....	53	397-07 Helen Recliner.....	56	528-RM Charleston Recliner.....	52
052H Bradley High Back Ease Back Chair.....	53	398-80 Talbot Sofa.....	66	529-RM Beaufort Recliner.....	50
108 Langthorn Guest Chair.....	122	400 Parkshore Sectional Series.....	79	530-RM Georgetown Recliner.....	52
GT-108-S Langthorn Executive Swivel.....	121	402 Conner Ease Back Chair, Ott.....	56	531-RM Barrington Recliner.....	50
109 Langthorn Tufted Back Guest Chair.....	122	403 Julius Bench.....	91	533-RM Barrineau Recliner.....	50
GT-109-S Langthorn Tufted Back Executive Swivel.....	121	404 Halifax Corner Chair.....	26	534 Brigham Ottoman.....	96
110 Langthorn Tufted Guest Chair.....	122	404-O Halifax Ottoman.....	94	534-36 Brigham Ottoman.....	96
GT-110-S Langthorn Tufted Executive Swivel.....	121	404-32 Halifax Armless Chair.....	26	534JB Sensation Ottoman.....	96
GT-113-S Shoreditch Executive Swivel.....	116	404-64 Halifax Settee.....	63	536 Wolfcreek Pass Chair.....	33
GT-114-S Brick Court Executive Swivel.....	116	406-94 Augustine Sofa.....	59	536-S Wolfcreek Pass Swivel Chair.....	42
GT-115-S Queen's Counsel Executive Swivel.....	118	407 Palmyra Chair.....	21	537-86 Stanhope Bench Seat Sofa.....	73
GT-116-S Keating Executive Swivel.....	124	407 Palmyra Sectional Series.....	78	537-HA7P Oasis Recliner w/ Power.....	47
GT-117-S Brixton Executive Swivel.....	116	409 Holborn Chair.....	28	537-IC7P Oasis Recliner w/ Power.....	47
GT-126-S Blackstone Executive Swivel.....	115	409-80 Holborn Sofa.....	68	537-JDO Oasis Recliner w/ Power.....	47
131-38 Henry Wing Chair.....	125	410 Farringdon Chair, Ott.....	30	537-048P Oasis Recliner.....	46
GT-135-S Fountain Court Executive Swivel.....	117	410-80 Farringdon Sofa.....	67	537-157 Oasis Recliner.....	47
139 Willem Dining Chair.....	106	415 Duncan Chair.....	25	537-168PC Oasis Recliner w/ Power & Chaise Pad.....	46
141-38 Reynolds Wing Chair, Ott.....	17	415-O Duncan Ottoman.....	57	537-247 Oasis Recliner.....	46
GT-143-S Doughty Street Executive Swivel.....	118	416 Punch Tavern Chair.....	22	537-368P Oasis Recliner w/ Power.....	46
GT-144-S Keating Tufted Executive Swivel.....	124	416-S Punch Tavern Swivel Chair.....	38	538 Loxley Chair, Ott.....	25
164 Barrister's Lobby Chair.....	12	432 Richardson Ave Chair, Ott.....	28	538 Cosmo Barstool.....	111
G-174-S Goose Alley Armless Executive Swivel.....	121	432-80 Richardson Ave Sofa.....	61	540-S Loxley Swivel Chair, Caster Ott.....	42
G-175-S Goose Alley Armless Tufted Executive Swivel.....	122	435 Aldersgate Chair, Ott.....	32	541-S Atticus Swivel Chair.....	41
186-CH Elm Row Guest Chair.....	114	435-47 Aldersgate Chair & A Half.....	32	545-S Asher Swivel Chair.....	41
GT-186-S Elm Row Executive Swivel.....	114	435-64 Aldersgate Loveseat.....	71	547 Bingeborough Chair, Ott.....	27
GT-199-S Westbourne Park Executive Swivel.....	120	435-89 Aldersgate Sofa.....	71	547-91 Bingeborough Sofa.....	67
214-02 Bamba Chair.....	5	435-106 Aldersgate Sofa.....	71	548 Devonshire Chair.....	27
214-02-27 Bamba Chair.....	5	435 Aldersgate Sectional Series.....	85	548-91 Devonshire Sofa.....	67
214-02-28 Bamba Chair.....	5	437 Carlisle Chair.....	28	553 Neon Ottoman.....	92
219-C Rainer Game Chair.....	13	437-80 Carlisle Sofa.....	66	553-18 Neon Ottoman.....	92
272-S Saddle II Swivel Chair.....	37	439-VT Camden Vari-Tilt, Ott.....	51	555-90 Poppins Court Sofa.....	73
273-S Dorset II Swivel Chair.....	37	440-VT Rockport Vari-Tilt, Ott.....	51	556 Kensington Library Chair.....	25
277-CH Peyton Chair.....	21	441-VT Cavendish Vari-Tilt.....	52	558 Findlay Chair, Ott.....	41
277-S Peyton Swivel Chair, Caster Ott.....	40	441-CH Cavendish Chair, Ott.....	30	558-83 Findlay Sofa.....	60
277-94 Peyton Sofa.....	65	441-87 Cavendish Sofa.....	71	560-90 Doyle Sofa.....	61
277 Peyton Sectional Series.....	80	450-GS Saddlebrook Track Arm Glider Swivel, Caster Ott.....	43	561-CH Padliegh Chair.....	23
278-CH Reilly Chair, Ott.....	23	451-GS Saddlebrook English Arm Glider Swivel, Caster Ott.....	43	561-S Padliegh Swivel Chair.....	38
278-S Reilly Swivel Chair, Caster Ott.....	40	454 MiddlePark Chair.....	33	562-94 Waitman Sofa.....	74
278-94 Reilly Sofa.....	65	454-78 MiddlePark Sofa.....	70	562-122 Waitman Four Seat Sofa.....	74
278 Reilly Sectional Series.....	81	454-55 MiddlePark Loveseat.....	70	565-90 Auburn Sofa.....	61
282-CH Sadler Chair.....	22	466 Keats Reading Chair.....	29	568 French Salon Chair.....	25
282-S Sadler Swivel.....	37	477 Isabella Chair, Ott.....	28	568-89 French Salon Sofa.....	64
283-CH Dorset Chair.....	22	499-66 Hayley Loveseat.....	63	576-RM Savannah Recliner.....	52
283-S Dorset Swivel.....	37	504-GS Saddlebrook Tufted Glider Swivel, Caster Ott.....	43	579 Carmichael Chair, Ott.....	24
284-SRM Parkhurst Swivel Recliner.....	51	506 Marlborough Lounge Chair.....	33	579-81 Carmichael Apartment Sofa.....	65
285-SRM Saxon Swivel Recliner.....	51	508 Lowell Swivel Barstool.....	109	579-91 Carmichael Sofa.....	65
287-RM Drayton Recliner.....	45	508-10 Lowell Armless Swivel Barstool.....	109	582-VT Ranelagh Vari-Tilt, Ott.....	45
289-94 Anaheim Sofa.....	59	508R Lowell Round Swivel Barstool.....	111	583-VT Rathmines Vari-Tilt, Ott.....	45
292-19 Kirkland Lounge Chair, Ott.....	34	510 Finsbury Chair, Ott.....	30	592-S Piccadilly Swivel Chair.....	40
GT-293-S Matrix Executive Swivel.....	116	510-83 Finsbury Sofa.....	68	592-61 Piccadilly Loft Loveseat.....	64
GT-295-S Essex Chambers Tufted Executive Swivel.....	120	510 Finsbury Sectional Series.....	84	592-80 Piccadilly Loft Apartment Sofa.....	64
297-07 Helen Recliner.....	56	513 Poppy Ottoman.....	90	592-88 Piccadilly Loft Sofa.....	64
GT-298-S Essex Chambers Executive Swivel.....	120	513C Poppy Ottoman with Casters.....	90	593-45 Orleans Chair & A Half.....	32
301-S Avanti Swivel Chair.....	42	513-30C Poppy Ottoman w/ Recessed Casters.....	91	593-98 Orleans Sofa.....	61
302-S Bayswater Swivel.....	38	518 Jasper Swivel Barstool.....	110	597 Whitby Fireside Wing Chair.....	29
303 Garrison Chair, Ott.....	24	523 Portia Ottoman.....	90	598-S Hampstead Swivel Chair.....	39
303-84 Garrison Sofa.....	62	524 Rebecca Ottoman.....	91	599 Pascal Chair, Ott.....	20
304 Keighley Chair, Ott.....	24	524 Lindsay Chair, Ott.....	29	599-83 Pascal Sofa.....	60
304-84 Keighley Sofa.....	62	524-83 Lindsay Sofa.....	67	613-25 Cambridge High Back Tilt Swivel Chair.....	118
305 Leeds Chair.....	22	525 Dowgate Hill Chair, Ott.....	27	613-88 Madison Sofa.....	59
305-84 Leeds Sofa.....	62	525-S Dowgate Hill Swivel Chair.....	39	623-18 Curtis Tilt Swivel Chair.....	124
306 Shelby Chair, Ott.....	24	525-58 Dowgate Hill Loveseat.....	74	623-38 Curtis Tilt Swivel Chair.....	124
306-84 Shelby Sofa.....	62	525-83 Dowgate Hill Sofa.....	74	663-15 Chandler Executive Chair.....	118

# NUMERICAL INDEX

695 Kenton Chair.....	21	837-O Billingsly Corners Tufted Bench.....	102	1447 Laney Recliner.....	49
698-O Baur Square Ottoman.....	102	839 Bergamo Chair.....	14	1607 Greg Recliner.....	49
699-O Baur Rectangle Ottoman.....	102	841 All Hallows Library Chair.....	13	1627 Anna Recliner.....	48
700-O Swaggy Ottoman.....	93	846 Bosworth Host Chair.....	18	1630 Kensington Sofa.....	59
701 Delray Cove Chair.....	13	847 Nantucket Cottage Chair.....	11	1652 Soho Chair.....	33
703-O Dover Court Bench.....	99	849-O Billingsly Bench.....	101	1652-SW Soho Swivel Chair.....	42
705 Andover Chair.....	6	851-O Trotter Tufted Bench.....	99	1757 Cary Recliner.....	49
705-52 Andover Settee.....	63	852-O Trotter Bench.....	99	1870 Jennings Sofa.....	66
706 Naples Cane Chair.....	8	856-O Gainsborough Bench.....	101	1960 Livingston Sofa.....	69
707-O Eastbourne Bench.....	99	859 Grand Victorian Wing Chair.....	16	2057SRM Mathis Heavy Duty Swivel Glider Recliner.....	54
708 Florence Chair.....	15	860 Jacoby Wing Chair.....	7	2070-88-38 Churchill Long Sofa.....	72
709 Celtic Gate Chair.....	10	863 Bonaparte Parlor Chair.....	11	2070-76-38 Churchill Sofa.....	72
710 Napa Valley Wing Chair.....	7	870-O Narcisse Bench.....	101	2070-67-38 Churchill Short Sofa.....	72
713 Victoria's Transition Wing Chair.....	16	872-O Palazzo Bench.....	103	2120/90-18 Wakefield Sofa.....	72
714 Nouvel Chair, Ott.....	10	877 Antoinette Chair.....	13	2380 Pearce Sofa.....	70
716-O Monticello Ottoman.....	103	882 San Baranto Chair.....	8	2380-88 Pearce Sofa.....	70
717 Porter's Evolution Chair.....	10	883-O Hadliegh Bench.....	101	2398 Hunter Accent Chair.....	12
718 Valois Button Chair.....	15	884-TO Emsworth Tray Ottoman.....	100	2407 Conner Recliner.....	56
719-BS Edam Bar Stool.....	108	890C-O Honeycomb Caster Bench.....	97	2427 Virgil Recliner.....	55
719-CS Edam Counter Stool.....	108	891-O Cardiff Bench.....	94	2530 Montana Sofa.....	69
721 Mission Viejo Chair.....	10	892C-O Continuation Bench.....	97	2560 Garland Sofa.....	69
725 Monastery Foyer Chair.....	8	893-O Continuation Tufted Bench.....	97	2630 Breckenridge Sofa.....	60
728-TO Hyde Park Tray Ottoman.....	100	894-O Emsworth Bench.....	100	2632 Breckenridge Chair.....	27
GT-730 Waning Crescent Executive Swivel.....	115	895C-O Honeycomb Skirted Ottoman.....	97	2670 Robinson Sofa.....	69
730 Waning Crescent Chair.....	6	911-04 Beaufort Ottoman.....	91	2672 Robinson Chair, Ott.....	31
731 Toulouse Chair.....	14	912-00/108 Maxine Sofa.....	58	2677H Robinson High Back Recliner.....	53
733-O Ellipsis.....	95	912 Maxine Sectional Series.....	76	2692 Fallon Swivel Chair.....	41
733C-O Ellipsis Caster.....	95	914 Carmel Sling Chair.....	5	2712 Acacia Swivel Chair.....	41
735 Adelaide Chair.....	11	914-O Carmel Sling Ottoman.....	89	2842 Zander Swivel Chair.....	38
736-O Ellipsis Banded.....	95	915-RK Wrenn Sling Rocking Chair.....	6	2852 Tate Chair.....	23
736C-O Ellipsis Banded Caster.....	95	915-O Wrenn Sling Rocking Ottoman.....	89	2852-SW Tate Swivel Chair.....	39
742-O Wexford Circle Ottoman.....	94	916-04/SQ1 Studio Ottoman.....	98	2898 Lodge Chair.....	23
744-OP/OAB Friars Bunching Bench.....	93	916-04/SQ2 Studio Ottoman.....	98	2898-SW Lodge Swivel Chair.....	39
745-OP/OAB Friars Hall Bench.....	93	917-07 Rhett Recliner.....	48	2947SR Hale Swivel Glider Recliner.....	55
747 Bellini Chair.....	14	918-04/RD1 Vivian Ottoman.....	98	3330 Logan Sectional Series.....	86
748-O Hyde Park Ottoman.....	100	920 Manhattan Sectional Series.....	130	3333 Logan Sofa.....	68
750 Julie Arm Dining Chair.....	106	920-00 Manhattan Sofa.....	127	3332 Lodge Chair, Ott.....	32
759-CS Montrose Counter Stool.....	107	920-00/40 Manhattan Sofa.....	127	3440-117 Rockies Sofa.....	58
762-O Chiclet Cube.....	92	920-02 Manhattan Lounge Chair, Ott.....	127	3440 Rockies Sectional Series.....	77
763 Oslo Chair.....	6	920-025W Manhattan Swivel Chair.....	36	4212 Romneus Swivel Chair.....	36
763-90 Oslo Sofa.....	23	921 Manhattan Sectional Series with Welt.....	130	4302 Blair Wing Chair.....	7
763-18HR Judge's Tilt Swivel Chair.....	123	921-00 Manhattan Sofa with Welt.....	127	4342-SW Susie Q Swivel Chair.....	36
764 Atwood Chair.....	11	926-02 Cloud Nine Chair, Ott.....	20	4612-SW Roush Swivel Chair.....	36
766-CS Abbott Counter Stool.....	107	926-00 Cloud Nine Sofa.....	58	4828-10 Charlie Armless Barstool.....	105
GT-766-S Rue Pouchet Executive Swivel.....	125	933-00 Shelly Sofa.....	60	4828L-10 Charlie Armless Counter Stool.....	105
767-O Wexford Place Bench.....	94	933-02 Shelly Chair, Ott.....	20	4829H-10 Charlie High Back Side Chair.....	105
770C-O Chiclet Caster Cube.....	92	933 Shelly Sectional Series.....	82	4829L-10 Charlie Low Back Side Chair.....	105
G-771-S Ava Executive Swivel.....	115	1010 St. Lucia Sofa.....	73	7072 Richmond Low Back Tilt Swivel Chair.....	117
771-BS Ava Barstool.....	108	1012 St. Lucia Chair, Ott.....	34	7112 French Empire Chair.....	14
771-CS Ava Counter Stool.....	108	1027 Forrest Recliner.....	53	7133 Thornton High Back Executive Tilt Swivel Chair.....	117
773-CS Basalt Counter Stool.....	107	1042 Blayne Chair, Ott.....	31	7173 Hutton Executive Chair.....	114
773-O Basalt Ottoman.....	89	1052 Bradley Chair.....	31	7193 Phelps Executive Chair.....	120
774 Valois Chair.....	15	1057-L Bradley Recliner w/ Lift Mechanism.....	54	7353 Lawton Executive Chair.....	115
775 Covington Side Dining Chair.....	106	1057SR Bradley Swivel Glider Recliner.....	54	8124 Hugh Bench.....	112
776 Covington Arm Dining Chair.....	106	1152 Wrenn Chair.....	30	8124H Hugh Bar Height Bench.....	112
793-18 Sullivan Tilt Swivel Chair.....	123	1218 Baxter Barstool.....	110	8128 Hugh Barstool.....	112
793-BS Hague Barstool.....	109	1231-17 Kelly Wing Chair.....	15	8213 Kent Executive Chair.....	114
793-CS Hague Counter Stool.....	109	1231-18 Kelly Wing Chair.....	16	9133 Asher High Back Tilt Swivel Chair.....	117
GT-796-S Bozeman Upper House Executive Swivel.....	123	1241-17 Alistair Wing Chair.....	17		
797-O Xander Bench.....	93	1241-18 Alistair Wing Chair.....	17		
798-O Trilogy Nesting Cocktail Ottoman.....	89	1241-38 Alistair Wing Chair.....	17		
802-S Knoll Swivel.....	40	1261-17 Kellan Wing Chair.....	7		
803-O Grimsby Bench.....	103	1337POP Tucker Recliner w/ Pop-Up Headrest.....	45		
806-O Dundee Bench.....	103	1357 Dixie Recliner.....	50		
809 Apothecary Barstool.....	111	1367-SG Roth Swivel Glider Recliner.....	55		
810 Apothecary Counter Stool.....	111	1377 Woody Recliner.....	49		
813 Haute Garrone Wing Chair, Ott.....	18	1387 Phantom Recliner.....	48		
836-O Billingsly Tufted Bench.....	102	1397POP Winston Recliner w/ Pop-Up Headrest.....	48		

\*See Price Book for Standard Features

# ALPHABETICAL INDEX

766-CS Abbott Counter Stool.....	107	2632 Breckenridge Chair.....	27	733C-O Ellipsis Caster.....	95
2712 Acacia Swivel Chair.....	41	2630 Breckenridge Sofa.....	60	186-CH Elm Row Guest Chair.....	114
735 Adelaide Chair.....	11	GT-114-S Brick Court Executive Swivel.....	116	GT-186-S Elm Row Executive Swivel.....	114
406-94 Augustine Sofa.....	59	534 Brigham Ottoman.....	96	894-O Emsworth Bench.....	100
435 Aldersgate Chair, Ott.....	32	534-36 Brigham Ottoman.....	96	884-TO Emsworth Tray Ottoman.....	100
435-47 Aldersgate Chair & A Half.....	32	GT-117-S Brixton Executive Swivel.....	116	GT-298-S Essex Chambers Executive Swivel.....	120
435-64 Aldersgate Loveseat.....	71	GT-796-S Bozeman Upper House Executive Swivel.....	123	GT-295-S Essex Chambers Tufted Executive Swivel.....	120
435-89 Aldersgate Sofa.....	71	613-25 Cambridge High Back Tilt Swivel Chair.....	118	2692 Fallon Swivel Chair.....	41
435-106 Aldersgate Sofa.....	71	439-VT Camden Vari-Tilt, Ott.....	51	410 Farrington Chair, Ott.....	30
435 Aldersgate Sectional Series.....	85	891-O Cardiff Bench.....	94	410-80 Farrington Sofa.....	67
841 All Hallows Library Chair.....	13	437 Carlisle Chair.....	28	558 Findlay Chair, Ott.....	41
1241-17 Alistair Wing Chair.....	17	437-80 Carlisle Sofa.....	66	558-83 Findlay Sofa.....	60
1241-18 Alistair Wing Chair.....	17	914 Carmel Sling Chair.....	5	510 Finsbury Chair, Ott.....	30
1241-38 Alistair Wing Chair.....	17	914-O Carmel Sling Ottoman.....	89	510-83 Finsbury Sofa.....	68
289-94 Anaheim Sofa.....	59	579 Carmichael Chair, Ott.....	24	510 Finsbury Sectional Series.....	84
705 Andover Chair.....	6	579-81 Carmichael Apartment Sofa.....	65	708 Florence Chair.....	15
705-52 Andover Settee.....	63	579-91 Carmichael Sofa.....	65	1027 Forrest Recliner.....	53
1627 Anna Recliner.....	48	1757 Cary Recliner.....	49	GT-135-S Fountain Court Executive Swivel.....	117
877 Antoinette Chair.....	13	441-CH Cavendish Chair, Ott.....	30	7112 French Empire Chair.....	14
809 Apothecary Barstool.....	111	441-VT Cavendish Vari-Tilt.....	52	568 French Salon Chair.....	25
810 Apothecary Counter Stool.....	111	441-87 Cavendish Sofa.....	71	568-89 French Salon Sofa.....	64
9133 Asher High Back Tilt Swivel Chair.....	117	709 Celtic Gate Chair.....	10	744-OP/OAB Friars Bunching Bench.....	93
545-S Asher Swivel Chair.....	41	663-15 Chandler Executive Chair.....	118	745-OP/OAB Friars Hall Bench.....	93
541-S Atticus Swivel Chair.....	41	528-RM Charleston Recliner.....	52	856-O Gainsborough Bench.....	101
764 Atwood Chair.....	11	4828-10 Charlie Armless Barstool.....	105	2560 Garland Sofa.....	69
565-90 Auburn Sofa.....	61	4828L-10 Charlie Armless Counter Stool.....	105	303 Garrison Chair, Ott.....	24
317 Austin Chair.....	21	4829H-10 Charlie High Back Side Chair.....	105	303-84 Garrison Sofa.....	62
771-BS Ava Barstool.....	108	4829L-10 Charlie Low Back Side Chair.....	105	530-RM Georgetown Recliner.....	52
771-CS Ava Counter Stool.....	108	762-O Chiclet Cube.....	92	G-174-S Goose Alley Armless Executive Swivel.....	121
G-771-S Ava Executive Swivel.....	115	770C-O Chiclet Caster Cube.....	92	G-175-S Goose Alley Armless Tufted Executive Swivel.....	122
301-S Avanti Swivel Chair.....	42	2070-88-38 Churchill Long Sofa.....	72	859 Grand Victorian Wing Chair.....	16
214-02 Bamba Chair.....	5	2070-67-38 Churchill Short Sofa.....	72	1607 Greg Recliner.....	49
214-02-27 Bamba Chair.....	5	2070-76-38 Churchill Sofa.....	72	803-O Grimsby Bench.....	103
214-02-28 Bamba Chair.....	5	926-02 Cloud Nine Chair, Ott.....	20	883-O Hadleigh Bench.....	101
773-CS Basalt Counter Stool.....	107	926-00 Cloud Nine Sofa.....	58	2947SR Hale Swivel Glider Recliner.....	55
773-O Basalt Ottoman.....	89	402 Conner Ease Back Chair, Ott.....	56	404 Halifax Corner Chair.....	26
531-RM Barrington Recliner.....	50	2407 Conner Recliner.....	56	404-32 Halifax Armless Chair.....	26
533-RM Barrineau Recliner.....	50	538 Cosmo Barstool.....	111	404-O Halifax Ottoman.....	94
164 Barrister's Lobby Chair.....	12	892C-O Continuation Bench.....	97	404-64 Halifax Settee.....	63
698-O Baur Square Ottoman.....	102	893-O Continuation Tufted Bench.....	97	793-BS Hague Barstool.....	109
699-O Baur Rectangle Ottoman.....	102	775 Covington Side Dining Chair.....	106	793-CS Hague Counter Stool.....	109
302-S Bayswater Swivel.....	38	776 Covington Arm Dining Chair.....	106	598-S Hampstead Swivel Chair.....	39
1218 Baxter Barstool.....	110	623-18 Curtis Tilt Swivel Chair.....	124	813 Haute Garrone Wing Chair, Ott.....	18
911-04 Beaufort Ottoman.....	91	623-38 Curtis Tilt Swivel Chair.....	124	499-66 Hayley Loveseat.....	63
529-RM Beaufort Recliner.....	50	701 Delray Cove Chair.....	13	297-07 Helen Recliner.....	56
839 Bergamo Chair.....	14	548 Devonshire Chair.....	27	397-07 Helen Recliner.....	56
747 Bellini Chair.....	14	548-91 Devonshire Sofa.....	67	131-38 Henry Wing Chair.....	125
849-O Billingsly Bench.....	101	1357 Dixie Recliner.....	50	409 Holborn Chair.....	28
836-O Billingsly Tufted Bench.....	102	283-CH Dorset Chair.....	22	409-80 Holborn Sofa.....	68
837-O Billingsly Corners Tufted Bench.....	102	273-S Dorset II Swivel Chair.....	37	890C-O Honeycomb Caster Bench.....	97
547 Bingeborough Chair, Ott.....	27	283-S Dorset Swivel.....	37	895C-O Honeycomb Skirted Ottoman.....	97
547-91 Bingeborough Sofa.....	67	GT-143-S Doughty Street Executive Swivel.....	118	8128 Hugh Barstool.....	112
390 Bishopsgate Chair.....	31	703-O Dover Court Bench.....	99	8124H Hugh Bar Height Bench.....	112
390-83 Bishopsgate Sofa.....	68	525 Dowgate Hill Chair, Ott.....	27	8124 Hugh Bench.....	112
GT-126-S Blackstone Executive Swivel.....	115	525-58 Dowgate Hill Loveseat.....	74	2398 Hunter Accent Chair.....	12
4302 Blair Wing Chair.....	7	525-83 Dowgate Hill Sofa.....	74	7173 Hutton Executive Chair.....	114
1042 Blayne Chair, Ott.....	31	525-S Dowgate Hill Swivel Chair.....	39	748-O Hyde Park Ottoman.....	100
042 Blayne Ease Back Chair, Ott.....	54	560-90 Doyle Sofa.....	61	728-TO Hyde Park Tray Ottoman.....	100
863 Bonaparte Parlor Chair.....	11	287-RM Drayton Recliner.....	45	477 Isabella Chair, Ott.....	28
846 Bosworth Host Chair.....	18	415 Duncan Chair.....	25	860 Jacoby Wing Chair.....	7
1052 Bradley Chair.....	31	415-O Duncan Ottoman.....	57	518 Jasper Swivel Barstool.....	110
052 Bradley Ease Back Chair.....	53	806-O Dundee Bench.....	103	1870 Jennings Sofa.....	66
052H Bradley High Back Ease Back Chair.....	53	707-O Eastbourne Bench.....	99	763-18HR Judge's Tilt Swivel Chair.....	123
1057-L Bradley Recliner w/ Lift Mechanism.....	54	719-BS Edam Bar Stool.....	108	403 Julius Bench.....	91
1057SR Bradley Swivel Glider Recliner.....	54	719-CS Edam Counter Stool.....	108	750 Julie Arm Dining Chair.....	106
526 Braidwood Chair, Ott.....	29	733-O Ellipsis.....	95	GT-116-S Keating Executive Swivel.....	124
526-79 Braidwood Sofa.....	66	736-O Ellipsis Banded.....	95	GT-144-S Keating Tufted Executive Swivel.....	124
526 Braidwood Sectional Series.....	83	736C-O Ellipsis Banded Caster.....	95	466 Keats Reading Chair.....	29

# ALPHABETICAL INDEX

304 Keighley Chair, Ott.....	24	763 Oslo Chair.....	6	282-CH Sadler Chair.....	22
304-84 Keighley Sofa.....	62	763-90 Oslo Sofa.....	23	282-S Sadler Swivel.....	37
1261-17 Kellan Wing Chair.....	7	537-048P Oasis Recliner.....	46	272-S Saddler II Swivel Chair.....	37
1231-17 Kelly Wing Chair.....	15	537-157 Oasis Recliner.....	47	882 San Baranto Chair.....	8
1231-18 Kelly Wing Chair.....	16	537-247 Oasis Recliner.....	46	576-RM Savannah Recliner.....	52
802-S Knoll Swivel.....	40	537-168PC Oasis Recliner w/ Power & Chaise Pad.....	46	285-SRM Saxon Swivel Recliner.....	51
8213 Kent Executive Chair.....	114	537-HA7P Oasis Recliner w/ Power.....	47	534JB Sensation Ottoman.....	96
695 Kenton Chair.....	21	537-IC7P Oasis Recliner w/ Power.....	47	306 Shelby Chair, Ott.....	24
556 Kensington Library Chair.....	25	537-JDO Oasis Recliner w/ Power.....	47	933-02 Shelly Chair, Ott.....	20
1630 Kensington Sofa.....	59	537-368P Oasis Recliner w/ Power.....	46	306-84 Shelby Sofa.....	62
292-19 Kirkland Lounge Chair, Ott.....	34	593-45 Orleans Chair & A Half.....	32	933-00 Shelly Sofa.....	60
108 Langthorn Guest Chair.....	122	593-98 Orleans Sofa.....	61	933 Shelly Sectional Series.....	82
GT-108-S Langthorn Executive Swivel.....	121	561-CH Padliegh Chair.....	23	GT-113-S Shoreditch Executive Swivel.....	116
GT-109-S Langthorn Tufted Back Executive Swivel.....	121	561-S Padliegh Swivel Chair.....	38	1652 Soho Chair.....	33
109 Langthorn Tufted Back Guest Chair.....	122	872-O Palazzo Bench.....	103	1652-SW Soho Swivel Chair.....	42
GT-110-S Langthorn Tufted Executive Swivel.....	121	407 Palmyra Chair.....	21	527 Stanhope Chair.....	34
110 Langthorn Tufted Guest Chair.....	122	407 Palmyra Sectional Series.....	78	537-86 Stanhope Bench Seat Sofa.....	73
1447 Laney Recliner.....	49	284-SRM Parkhurst Swivel Recliner.....	51	527-86 Stanhope Sofa.....	73
7353 Lawton Executive Chair.....	115	400 Parkshore Sectional Series.....	79	1010 St. Lucia Sofa.....	73
305 Leeds Chair.....	22	599 Pascal Chair, Ott.....	20	1012 St. Lucia Chair, Ott.....	34
305-84 Leeds Sofa.....	62	599-83 Pascal Sofa.....	60	916-04/SQ1 Studio Ottoman.....	98
524 Lindsay Chair, Ott.....	29	2380 Pearce Sofa.....	70	916-04/SQ2 Studio Ottoman.....	98
524-83 Lindsay Sofa.....	67	2380-88 Pearce Sofa.....	70	793-18 Sullivan Tilt Swivel Chair.....	123
1960 Livingston Sofa.....	69	277-CH Peyton Chair.....	21	4342-SW Susie Q Swivel Chair.....	36
3332 Lodge Chair, Ott.....	32	277-94 Peyton Sofa.....	65	700-O Swaggy Ottoman.....	93
2898 Lodge Chair.....	23	277 Peyton Sectional Series.....	80	398-80 Talbot Sofa.....	66
2898-SW Lodge Swivel Chair.....	39	277-S Peyton Swivel Chair, Caster Ott.....	40	2852 Tate Chair.....	23
3333 Logan Sofa.....	68	1387 Phantom Recliner.....	48	2852-SW Tate Swivel Chair.....	39
3330 Logak Sectional Series.....	86	7193 Phelps Executive Chair.....	120	7133 Thornton High Back Executive Tilt Swivel Chair.....	117
337 Lombard St Bankers Chair.....	12	592-80 Piccadilly Loft Apartment Sofa.....	64	798-O Trilogy Nesting Cocktail Ottoman.....	89
337-C Lombard St Bankers Caster Chair.....	12	592-61 Piccadilly Loft Loveseat.....	64	851-O Trotter Tufted Bench.....	99
508-10 Lowell Armless Swivel Barstool.....	109	592-88 Piccadilly Loft Sofa.....	64	852-O Trotter Bench.....	99
508 Lowell Swivel Barstool.....	109	592-S Piccadilly Swivel Chair.....	40	731 Toulouse Chair.....	14
508R Lowell Round Swivel Barstool.....	111	555-90 Poppins Court Sofa.....	73	1337POP Tucker Recliner w/ Pop-Up Headrest.....	45
538 Loxley Chair, Ott.....	25	513 Poppy Ottoman.....	90	562-94 Waitman Sofa.....	74
540-S Loxley Swivel Chair, Caster Ott.....	42	513C Poppy Ottoman with Casters.....	90	562-122 Waitman Four Seat Sofa.....	74
613-88 Madison Sofa.....	59	513-30C Poppy Ottoman w/ Recessed Casters.....	91	2120/90-18 Wakefield Sofa.....	72
920-02 Manhattan Lounge Chair, Ott.....	127	717 Porter's Evolution Chair.....	10	730 Waning Crescent Chair.....	6
920-00 Manhattan Sofa.....	127	523 Portia Ottoman.....	90	GT-730 Waning Crescent Executive Swivel.....	115
920-00/40 Manhattan Sofa.....	127	416 Punch Tavern Chair.....	22	GT-199-S Westbourne Park Executive Swivel.....	120
40-0-114 Manhattan Sofa.....	128	416-S Punch Tavern Swivel Chair.....	38	742-O Wexford Circle Ottoman.....	94
40-0-313 Manhattan Sofa.....	128	GT-115-S Queen's Counsel Executive Swivel.....	118	767-O Wexford Place Bench.....	94
40-0-434 Manhattan Sofa.....	128	219-C Rainer Game Chair.....	13	139 Willem Dining Chair.....	106
40-0-533 Manhattan Sofa.....	128	582-VT Ranelagh Vari-Tilt, Ott.....	45	1397POP Winston Recliner w/ Pop-Up Headrest.....	48
920 Manhattan Sectional Series.....	130	583-VT Rathmines Vari-Tilt, Ott.....	45	597 Whitby Fireside Wing Chair.....	29
921-00 Manhattan Sofa with Welt.....	127	524 Rebecca Ottoman.....	91	1377 Woody Recliner.....	49
921 Manhattan Sectional Series with Welt.....	130	278-CH Reilly Chair, Ott.....	23	536 Wolfcreek Pass Chair.....	33
920-02SW Manhattan Swivel Chair.....	36	278-94 Reilly Sofa.....	65	536-S Wolfcreek Pass Swivel Chair.....	42
506 Marlborough Lounge Chair.....	33	278 Reilly Sectional Series.....	81	1152 Wrenn Chair.....	30
2057SRM Mathis Heavy Duty Swivel Glider Recliner.....	54	278-S Reilly Swivel Chair, Caster Ott.....	40	915-RK Wrenn Sling Rocking Chair.....	6
GT-293-S Matrix Executive Swivel.....	116	141-38 Reynolds Wing Chair, Ott.....	17	915-O Wrenn Sling Rocking Ottoman.....	89
912-00/108 Maxine Sofa.....	58	917-07 Rhett Recliner.....	48	774 Valois Chair.....	15
912 Maxine Sectional Series.....	76	432 Richardson Ave Chair, Ott.....	28	718 Valois Button Chair.....	15
454 MiddlePark Chair.....	33	432-80 Richardson Ave Sofa.....	61	713 Victoria's Transition Wing Chair.....	16
454-55 MiddlePark Loveseat.....	70	7072 Richmond Low Back Tilt Swivel Chair.....	117	2427 Virgil Recliner.....	55
454-78 MiddlePark Sofa.....	70	2672 Robinson Chair, Ott.....	31	918-04/RD1 Vivian Ottoman.....	98
721 Mission Viejo Chair.....	10	2677H Robinson High Back Recliner.....	53	797-O Xander Bench.....	93
725 Monastery Foyer Chair.....	8	2670 Robinson Sofa.....	69	2842 Zander Swivel Chair.....	38
2530 Montana Sofa.....	69	3440-117 Rockies Sofa.....	58		
716-O Monticello Ottoman.....	103	3440 Rockies Sectional Series.....	77		
759-CS Montrose Counter Stool.....	107	440-VT Rockport Vari-Tilt, Ott.....	51		
847 Nantucket Cottage Chair.....	11	4212 Romneus Swivel Chair.....	36		
710 Napa Valley Wing Chair.....	7	1367-SG Roth Swivel Glider Recliner.....	55		
706 Naples Cane Chair.....	8	4612-SW Roush Swivel Chair.....	36		
870-O Narcisse Bench.....	101	GT-766-S Rue Pouchet Executive Swivel.....	125		
714 Nouvel Chair, Ott.....	10	451-GS Saddlebrook English Arm Glider Swivel, Caster Ott.....	43		
553 Neon Ottoman.....	92	450-GS Saddlebrook Track Arm Glider Swivel, Caster Ott.....	43		
553-18 Neon Ottoman.....	92	504-GS Saddlebrook Tufted Glider Swivel, Caster Ott.....	43		



EXTRAORDINARILY COMFORTABLE FURNITURE FOR THE QUALITY OBSESSED



## CONTACT

Phone: (828) 326 . 6100

Fax: (828) 326 . 6101

Website: [www.leathercraft-furniture.com](http://www.leathercraft-furniture.com)

Website: [www.ourhousedesigns.com](http://www.ourhousedesigns.com)

Email: [leathercraft@ourhousedesigns.com](mailto:leathercraft@ourhousedesigns.com)

## SHIPPING & MAILING ADDRESS

6429 Hildebran-Shelby Road, Hickory, NC 28602